

OPERATING INSTRUCTIONS FOR

Model 3350

Oxygen Alarm Monitor

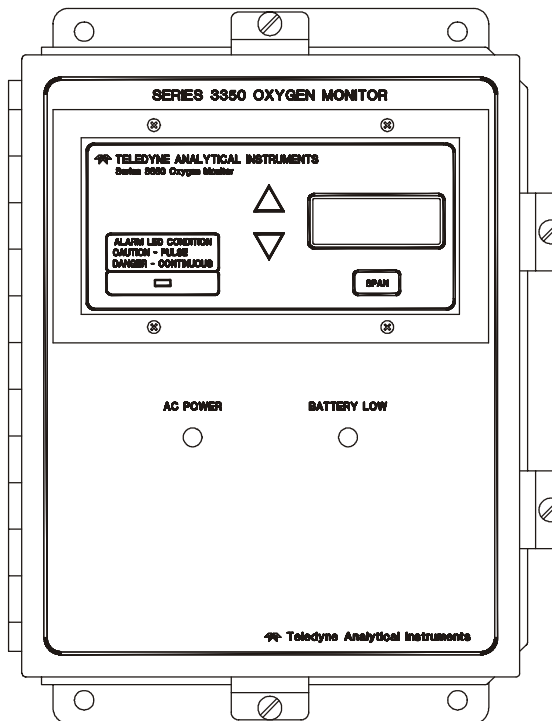

DANGER



HIGHLY TOXIC AND OR FLAMMABLE LIQUIDS OR GASES MAY BE PRESENT IN THIS MONITORING SYSTEM.

PERSONAL PROTECTIVE EQUIPMENT MAY BE REQUIRED WHEN SERVICING THIS SYSTEM.

HAZARDOUS VOLTAGES EXIST ON CERTAIN COMPONENTS INTERNALLY WHICH MAY PERSIST FOR A TIME EVEN AFTER THE POWER IS TURNED OFF AND DISCONNECTED.

ONLY AUTHORIZED PERSONNEL SHOULD CONDUCT MAINTENANCE AND/OR SERVICING. BEFORE CONDUCTING ANY MAINTENANCE OR SERVICING CONSULT WITH AUTHORIZED SUPERVISOR/MANAGER.

P/NM70682
04/28/99
ECO# 99-0116

Copyright © 1999 Teledyne Analytical Instruments

All Rights Reserved. No part of this manual may be reproduced, transmitted, transcribed, stored in a retrieval system, or translated into any other language or computer language in whole or in part, in any form or by any means, whether it be electronic, mechanical, magnetic, optical, manual, or otherwise, without the prior written consent of Teledyne Analytical Instruments, 16830 Chestnut Street, City of Industry, CA 91749-1580.

Warranty

This equipment is sold subject to the mutual agreement that it is warranted by us free from defects of material and of construction, and that our liability shall be limited to replacing or repairing at our factory (without charge, except for transportation), or at customer plant at our option, any material or construction in which defects become apparent within one year from the date of shipment, except in cases where quotations or acknowledgements provide for a shorter period. Components manufactured by others bear the warranty of their manufacturer. This warranty does not cover defects caused by wear, accident, misuse, neglect or repairs other than those performed by Teledyne or an authorized service center. We assume no liability for direct or indirect damages of any kind and the purchaser by the acceptance of the equipment will assume all liability for any damage which may result from its use or misuse.

We reserve the right to employ any suitable material in the manufacture of our apparatus, and to make any alterations in the dimensions, shape or weight of any parts, in so far as such alterations do not adversely affect our warranty.

Important Notice

This instrument provides measurement readings to its user, and serves as a tool by which valuable data can be gathered. The information provided by the instrument may assist the user in eliminating potential hazards caused by his process; however, it is essential that all personnel involved in the use of the instrument or its interface, with the process being measured, be properly trained in the process itself, as well as all instrumentation related to it.

The safety of personnel is ultimately the responsibility of those who control process conditions. While this instrument may be able to provide early warning of imminent danger, it has no control over process conditions, and it can be misused. In particular, any alarm or control systems installed must be tested and understood, both as to how they operate and as to how they can be defeated. Any safeguards required such as locks, labels, or redundancy, must be provided by the user or specifically requested of Teledyne at the time the order is placed.

Therefore, the purchaser must be aware of the hazardous process conditions. The purchaser is responsible for the training of personnel, for providing hazard warning methods and instrumentation per the appropriate standards, and for ensuring that hazard warning devices and instrumentation are maintained and operated properly.

Teledyne Analytical Instruments (TAI), the manufacturer of this instrument, cannot accept responsibility for conditions beyond its knowledge and control. No statement expressed or implied by this document or any information disseminated by the manufacturer or its agents, is to be construed as a warranty of adequate safety control under the user's process conditions.

Model 3350 complies with all of the requirements of the Commonwealth of Europe (CE) for Radio Frequency Interference, Electromagnetic Interference (RFI/EMI), and Low Voltage Directive (LVD).

The following International Symbols are used throughout the Instruction Manual for your visual and immediate warnings and when you have to attend CAUTION while operating the instrument:



GROUND
Protective Earth



CAUTION, The operator needs to refer to the manual for further information. Failure to do so may compromise the safe operation of the equipment.



CAUTION, Risk of Electric Shock

Contents

Introduction

1.1 Overview	1-1
1.2 Main Features of the Analyzer	1-1
1.3 Front Panel Description	1-2
1.4 Rear Panel Description	1-3

Operational Theory

2.1 Introduction	2-1
2.2 Micro-Fuel Cell Sensor	2-1
2.2.1 Principles of Operation	2-1
2.2.2 Anatomy of a Micro-Fuel Cell	2-2
2.2.3 Electrochemical Reactions	2-3
2.2.4 The Effect of Pressure	2-3
2.2.5 Calibration Characteristics	2-4
2.3 Electronics	2-5
2.3.1 General	2-5
2.3.2 Signal Processing	2-5
2.4 Alarms	2-6

Installation

3.1 Unpacking the Analyzer	3-1
3.2 Installation	3-2
3.3 Installing the Micro-Fuel Cell	3-2
3.4 Electrical Connections	3-2
3.5 Power and Signal Connections	3-3
3.5.1 AC and Battery Backed Standby Power	3-3
3.5.2 Battery Backed Standby Power	3-4
3.5.2.1 Connecting the Rechargeable Battery	3-5
3.5.3 Analog Outputs	3-6
3.5.4 RS-232 Port (optional)	3-6
3.5.5 Alarm Relays	3-7
3.6 Calibration	3-8
3.7 Operation	3-9
3.8 Cell Warranty	3-10
3.9 Safety Checklist	3-10

3.10 Accessory Flow-Through Adapter	3-11
---	------

Operation

4.1 Using the Function and Data Entry Buttons	4-1
4.2 Alarm Conditions	4-2
4.3 Calibration	4-2

Maintenance

5.1 Replacing the Fuse	5-1
5.1.1 Standard AC Version	5-1
5.1.2 AC with Battery Backup Version	5-2
5.2 Sensor Installation or Replacement	5-2
5.2.1 When to Replace a Sensor	5-2
5.2.2 Ordering and Handling of Spare Sensors	5-3
5.2.3 Removing the Micro-Fuel Cell	5-3
5.2.4 Installing a Micro-Fuel Cell	5-4
5.2.5 Cell Warranty Conditions	5-4

Appendix

A.1 Specifications	A-1
A.2 Spare Parts List	A-2
A.3 Reference Drawing	A-3
A.4 Miscellaneous	A-3



This is a general purpose instrument designed for usage in a nonhazardous area. It is the customer's responsibility to ensure safety especially when combustible gases are being analyzed since the potential of gas leaks always exist.

The customer should ensure that the principles of operating of this equipment is well understood by the user. Misuse of this product in any manner, tampering with its components, or unauthorized substitution of any component may adversely affect the safety of this instrument.

Since the use of this instrument is beyond the control of Teledyne, no responsibility by Teledyne, its affiliates, and agents for damage or injury from misuse or neglect of this equipment is implied or assumed.

Introduction

1.1 Overview

The Teledyne Electronic Technologies Analytical Instruments (TET/AI) Model 3350 is a microprocessor-based Oxygen Alarm Monitor for real-time measurement of the oxygen content of the atmosphere surrounding its sensor.

The Model 3350 standard instrument is configured to run from an AC power source and is also available with continuous charging, DC battery backup option. The rated battery life is approximately 17 hours configured in failsafe mode and 48 hours in non-failsafe mode.

The instrument is designed as a safety monitor. However, it is the responsibility of the user to establish whether or not the total system or instrument, environment, alarm components and any other relevant devices will actually assure safety in his/her particular circumstances.

1.2 Main Features of the Analyzer

- Accurate readings of oxygen content at the standard 0-25% range. (Consult factory for other ranges)
- Large, bright, light emitting diode meter readout.
- Nylon cell holder.
- Simple pushbutton span controls.
- Advanced Micro-fuel Cell, for percent analysis, has a two year warranty and an expected life of four years.
- Unaffected by oxidizing gasses.
- Fast response and recovery time.
- Microprocessor based electronics: 8bit CMOS microprocessor with on-board RAM and 16KB ROM.
- Air calibration range for convenient spanning at 20.9% oxygen.

- Two factory preset alarms, form C relay contacts, configured as Failsafe or Non-Failsafe.
- Sensor failure alarm, form C relay contact, configured as Failsafe or Non-Failsafe.
- Three analog outputs: two for measurement (0–10 VDC, and negative ground 4–20 mADC) and one for range identification (0-10 VDC).
- Optional RS232
- Compact and rugged, wall mounted NEMA-4 rated enclosure.
- CE Approval

1.3 Front Panel Description

All controls and displays except the power switch are accessible from the front panel. See Figure 1-1. The front panel has three pushbutton membrane switches, a digital meter, and an alarm indicator LED for operating the monitor. These features are described briefly here and in greater detail in Chapter 4, *Operation*.

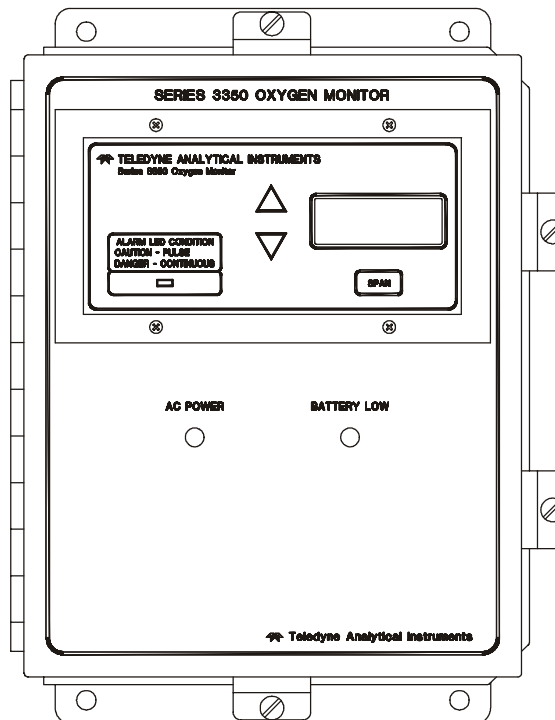

Figure 1-1: Front Panel

Span Key: Pushbutton membrane switch is used to span calibrate the analyzer:

Data Entry Keys: Two pushbutton membrane switches are used to manually change the span measurement parameters of the instrument as they are displayed on the LED meter readout:

- **Up Arrow** Increment values of parameters upwards as they are displayed on the LED readout.
- **Down Arrow** Increment values of parameters downwards as they are displayed on the LED readout.

Digital LED Readout: The digital display is a LED device that produces large, bright, 7-segment numbers that are legible in any lighting environment. It has three functions:

- **Meter Readout:** As the meter readout, it displays the oxygen concentration currently being measured.
- **Measurement Parameters Readout:** It displays the span calibration point when it is being checked or changed.
- **Alarm Condition:** It displays intermittently, “CAUt” and the gas readings when a CAUTION Alarm has been initiated and “dAng” for DANGER Alarm.

1.4 Rear Panel Description

The rear panel contains the electrical input and output connectors. Separate rear panel illustrations are shown in figure 1-2 for the AC and DC battery backup versions of the instrument. The connectors are described briefly here and in detail in the *Installation* chapter of this manual.

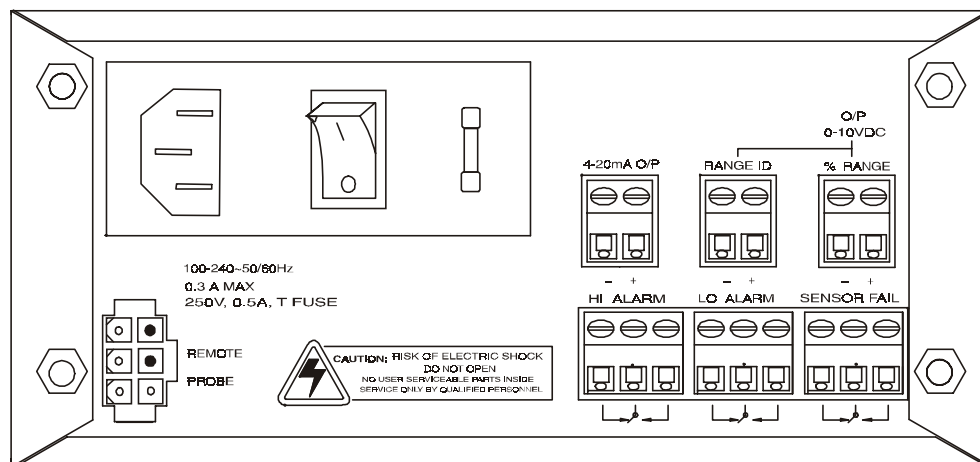

Figure 1-2 Rear Panel, Control Unit - AC

(viewed from inside front door)

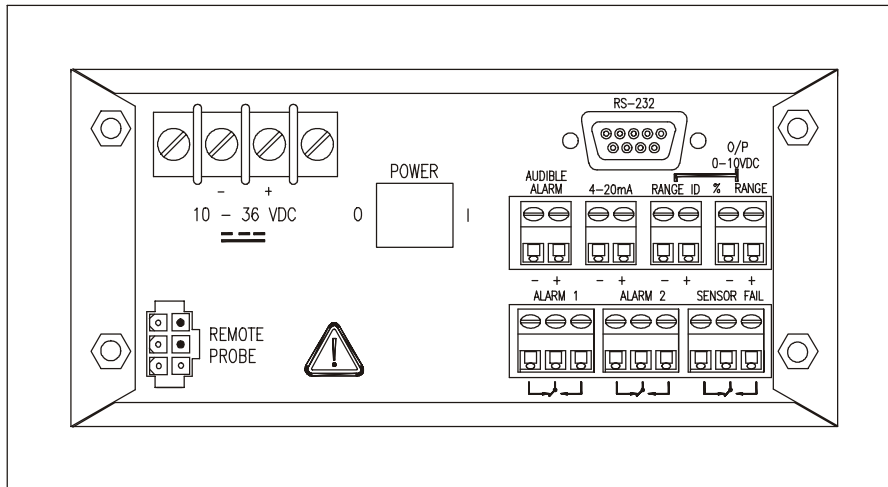

Figure 1-2 Rear Panel, Control Unit - DC
(viewed from inside front door)

- **Power Connection** *AC version:* Universal 100–240 VAC, at 50/60Hz. The connector housing includes the fuse holder and the power switch.

DC Battery Backup Version: , 10 to 36 VDC. Supplied by universal 100-240VAC.

Fuse Holder: Replacing the fuses is described in Chapter 5, *Maintenance*.

I/O Power Switch: Turns the instrument power ON (1) or OFF (0).
- **Analog Outputs** **0–10 VDC** concentration output.

0–10 VDC range ID (or optional overrange) output.

4–20 mA DC concentration output, negative ground.
- **Digital Output** RS232 (optional).
- **Audible Alarm** Output for standard internal or customer supplied external audible alarm (12VDC@5mA).
- **Alarm Connections** Alarm 1 (CAUTION), Alarm 2 (DANGER), and Sensor Failure Alarm connections.
- **Sensor Connector** Sensor Connector.

Operational Theory

2.1 Introduction

The analysis is specific for oxygen, i.e., the measuring cell will not generate an output current unless oxygen is present in the sample gas. Thus, the instrument has an absolute zero and no zero gas is required to operate the analyzer.

The measuring cell has the ability to respond accurately to the presence of oxygen irrespective of flowrate. TAI recommends using ambient air as a span gas or, if that is not possible, using a known calibration gas of about 80% of the range of interest value.

The measuring cell (U.S. Patent #3,429,796) is a solid-state maintenance-free structure that carries a TAI guarantee for performance and usable life. The cell consumes oxygen from the gas surrounding it and generates a proportional microampere current. The Control Unit processes the sensor output and translates it into electrical concentration, range, and alarm outputs, and a percent oxygen meter readout. It contains a microcontroller that manages all signal processing, input/output, and display functions for the analyzer.

2.2 Micro-Fuel Cell Sensor

2.2.1 Principles of Operation

The oxygen sensor used in the Model 3350 is a Micro-fuel Cell designed and manufactured by TAI. It is a sealed, disposable electrochemical transducer.

The active components of the Micro-Fuel Cell are a cathode, an anode, and the aqueous KOH electrolyte in which they are immersed. The cell converts the energy from a chemical reaction into an electrical potential that can produce a current in an external electrical circuit. Its action is similar to that of a battery.

There is, however, an important difference in the operation of a battery as compared to the Micro-Fuel Cell: In the battery, all reactants are stored within the cell, whereas in the Micro-Fuel Cell, one of the reactants (oxygen) comes from outside the device as a constituent of the sample gas being analyzed. The Micro-Fuel Cell is therefore a hybrid between a battery and a true fuel cell. (All of the reactants are stored externally in a true fuel cell.)

2.2.2 Anatomy of a Micro-Fuel Cell

The Micro-Fuel Cell is made of extremely inert plastic (which can be placed confidently in practically any environment or sample stream). It is effectively sealed, though one end is permeable to oxygen in the sample gas. At the permeable end a screen retains a diffusion membrane through which the oxygen passes into the cell. At the other end of the cell is a connector and temperature compensation network (restrictors and thermistor) on a printed circuit board.

Refer to Figure 2-1, *Basic Elements of a Micro-Fuel Cell*, which illustrates the following internal description.

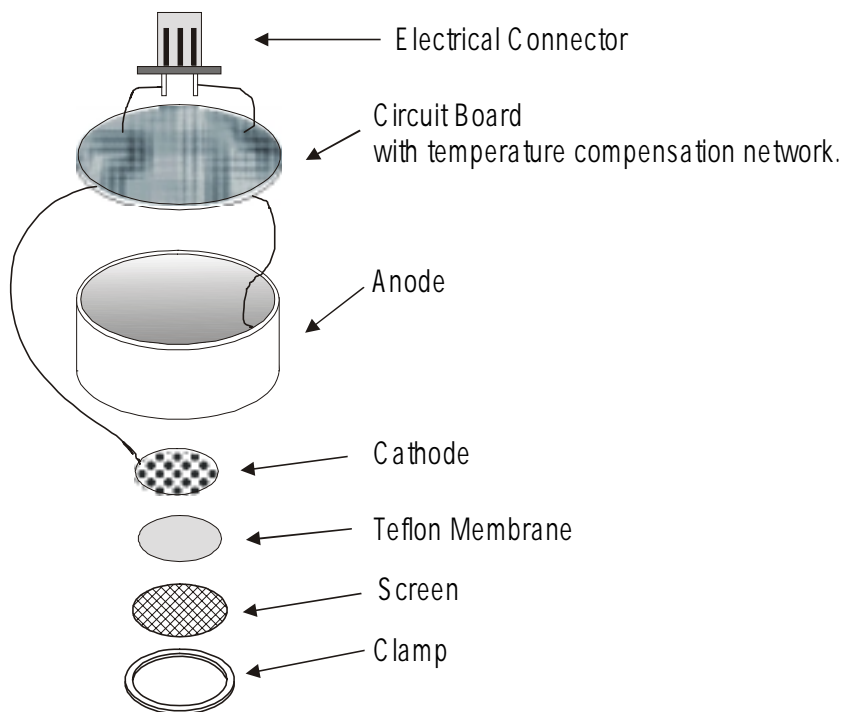

Figure 2-1. *Basic Elements of a Micro-Fuel Cell (not to scale)*

At the sensing end of the cell is a diffusion membrane, whose thickness is very accurately controlled. Near the diffusion membrane lies the oxygen sensing element—the cathode.

The anode structure is larger than the cathode. It is made of lead and is designed to maximize the amount of metal available for chemical reaction.

The space between the active elements is filled by a structure saturated with electrolyte. Cathode and anode are wet by this common pool. They each have a conductor connecting them, through some electrical circuitry, to one of the external contacts in the connector receptacle, which is on the top of the cell.

2.2.3 Electrochemical Reactions

The sample gas diffuses through the Teflon membrane. Any oxygen in the sample gas is reduced on the surface of the cathode by the following HALF REACTION:



(Four electrons combine with one oxygen molecule—in the presence of water from the electrolyte—to produce four hydroxyl ions.)

When the oxygen is reduced at the cathode, lead is simultaneously oxidized at the anode by the following HALF REACTION:

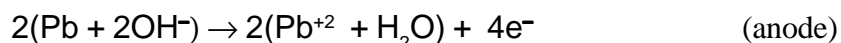

(Two electrons are transferred for each atom of lead that is oxidized. TWO ANODE REACTIONS balance one cathode reaction to transfer four electrons.)

The electrons released at the surface of the anode flow to the cathode surface when an external electrical path is provided. The current is proportional to the amount of oxygen reaching the cathode. It is measured and used to determine the oxygen concentration in the gas mixture.

The overall reaction for the fuel cell is the SUM of the half reactions above, or:

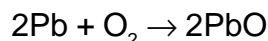

(These reactions will hold as long as no gaseous components capable of oxidizing lead are present in the sample. The only likely components are the halogens—iodine, bromine, chlorine and fluorine.)

The output of the fuel cell is limited by (1) the amount of oxygen in the cell at the time and (2) the amount of stored anode material.

In the absence of oxygen, no current is generated.

2.2.4 The Effect of Pressure

In order to state the amount of oxygen present in the sample as a percentage of the gas mixture, it is necessary that the sample diffuse into the cell under constant pressure.

If the pressure changes, the rate that oxygen reaches the cathode through the diffusing membrane will also increase. The electron transfer, and therefore the external current, will increase, even though the proportion of oxygen has not changed.

Fortunately, Dalton's Law confirms that every gas in a mixture contributes the same pressure to the mixture that it would exert if it were alone in the same

amount in that same volume. This means that as long as the total pressure of the sample remains constant, the mixture can change, but the diffusion of the oxygen will be affected only by the concentration of the oxygen.

For this reason, the sample system supplying sample gas to the cell should be designed to keep the pressure on the diffusion membrane constant.

2.2.5 Calibration Characteristics

Given that the total pressure of the sample gas at the surface of the Micro-Fuel Cell input is constant, a convenient characteristic of the cell is that the current produced in an external circuit of constant impedance is directly proportional to the rate at which oxygen molecules reach the cathode, and this rate is directly proportional to the concentration of oxygen in the gaseous mixture. In other words it has a linear characteristic curve, as shown in Figure 2-2. Measuring circuits do not have to compensate for nonlinearities.

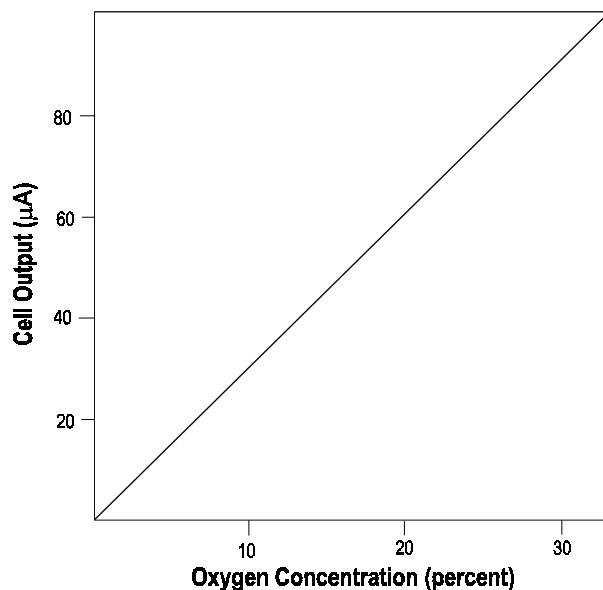

Figure 2-2. Characteristic Input/Output Curve for a Micro-Fuel Cell

In addition, since there is zero output in the absence of oxygen, the characteristic curve has an absolute zero. The cell itself does not need to be zeroed.

2.3 Electronics

2.3.1 General

The signal processing uses an Intel® microcontroller with on-board RAM and ROM to control all signal processing, input/output, and display functions for the analyzer. System power is supplied from a universal power supply module designed to be compatible with most international power sources.

The power supply circuitry is on the Power Supply PCB, which is mounted vertically, just behind the rear panel of the Control Unit.

The signal processing electronics including the sensor amplifier, microcontroller, analog to digital, and digital to analog converters are located on the Main PCB, which is mounted vertically, just behind the front panel of the Control Unit.

2.3.2 Signal Processing

Figure 2-3 is a block diagram of the signal processing electronics described below.

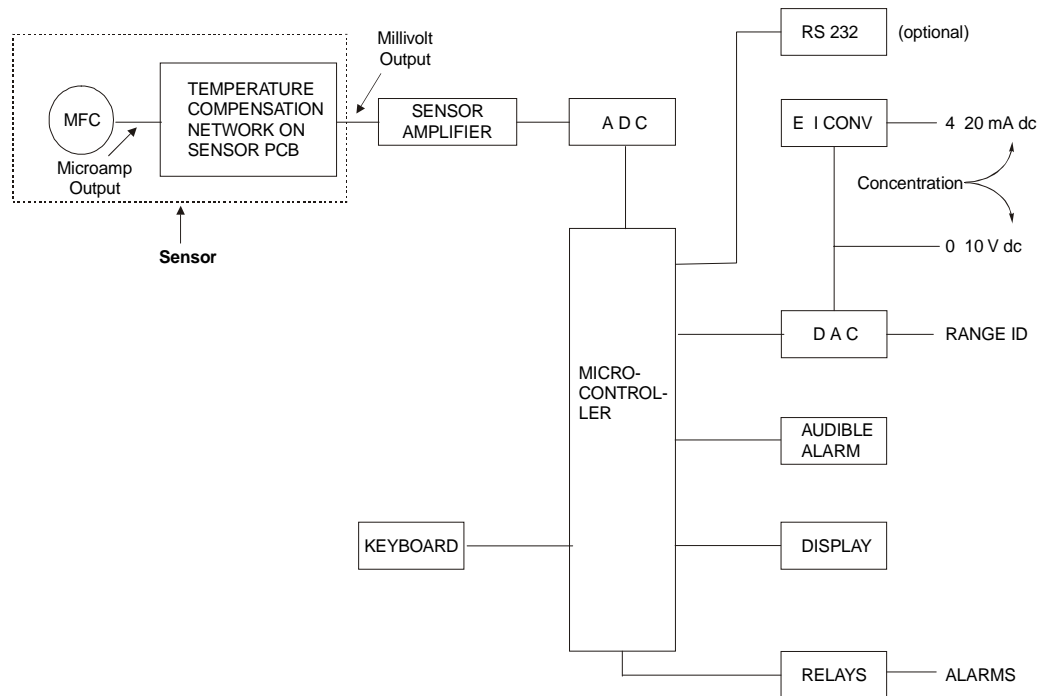

Figure 2-3: Block Diagram of the Signal Processing Electronics

In the presence of oxygen the cell generates a current. The sensor has an internal thermistor compensation network.

The output of the sensor is converted to millivolts. This output is fed to a voltage amplifier. The internal thermistor network provides temperature compensation of the sensor output. The resistance of the network changes with temperature, compensating for the changes of the microfuel cell output to temperature.

The output from the temperature compensation amplifier is sent to an analog to digital converter (ADC), and the resulting digital concentration signal is sent to the microcontroller.

The digital concentration signal along with input from the front panel buttons (KEYBOARD) is processed by the microcontroller, and appropriate output signals are directed to the display and alarm relays. The same digital information is also sent to a 12-bit digital to analog converter (DAC) that produces the 0-10 V dc analog concentration signal and the 0-10 V dc analog range ID output. A voltage to current converter (E-ICONV) produces the 4-20 mA dc analog concentration signal.

2.4 Alarms

When the alarm setpoints are properly adjusted, they provide an operational band that covers all acceptable oxygen concentrations. If the oxygen level at the sensor crosses the adjusted setpoint of one of the alarms, that alarm will cause the switching of relay contacts. Normally open (N.O.) and normally closed (N.C.) circuit connections at the interconnection terminal strip will be reversed. Thus, a circuit that is open (turned off) in a non-alarm condition will be closed (turned on) when its alarm is activated, and vice-versa.

As per OSHA specifications, the standard factory setting of the two alarms provides a "CAUTION" (Alarm 1) alarm at 20% oxygen (at the sensor) and a "DANGER" (Alarm 2) alarm at 19.5% oxygen. To cover special cases, a limited amount of adjustment is possible.

Installation

Installation of the analyzer includes:

1. Unpacking the system.
2. Mounting the Control Unit to a wall
3. Installing the Micro-Fuel Cell
4. Connecting the battery
5. Making the electrical connections.
6. Testing the installation.

CAUTIONS: Read this chapter in its entirety before installing the units.



The Micro-Fuel Cell sensor electrolyte is caustic. Do not attempt to open it. Leaking or exhausted cells should be disposed of in accordance with local regulations. Refer to the Material Safety Data Sheet in the Appendix.

Any damage or scarring of the delicate permeable membrane on the sensing end of the cell will require cell replacement. Prevent contact with membrane by any solid object.

3.1 Unpacking the Analyzer

As soon as you receive the instrument, carefully unpack and inspect Control Unit, and any included accessories for damage. Immediately report any damage to the shipping agent. The analyzer is shipped with all the materials you need to install and prepare the system for operation.

CAUTION: Do not disturb the integrity of the cell package until the cell is to actually be used. If the cell package is punctured and air is permitted to enter, cell-life will be compromised.

3.2 Installation

The 3350 is designed to be wall-mounted, in a general purpose, area. The unit should be installed at viewing level in a sheltered area, if possible. The installation consists of installing the MFC, connecting the rechargeable battery (if applicable) and connecting the instrument to AC power..

Refer to the Outline diagram D-70679 for the physical dimensions of the analyzer.

For CE Compliant Installation: If the unit is installed without the power cord, a switch or circuit breaker must be installed in close proximity to the analyzer to break both sides of the line with a rating of 3A at 250V~ minimum. The minimum recommended wire is 16 AWG 250VAC.



3.3 Installing the Micro-Fuel Cell

The Micro-Fuel Cell is shipped separately from the instrument and must be installed before operating the instrument. Turn the instrument off and disconnect the AC power.

To install the cell in the probe assembly:

1. Remove the probe from its holder on the outside of the instrument case and remove the cell from its sealed shipping package.
2. Unscrew the cap from the top of the probe assembly.
3. Remove the shorting clip from the cell.
4. Place the cell in the probe with the terminal end facing down toward the probe contacts and the soft membrane surface facing the outside.
5. Replace the probe cap, making sure that it is all the way down and seated on the probe body, then replace the probe assembly into its holder.



3.4 Electrical Connections

Figures 3-1 through 3-4 show the two alternate Model 3350 AC power connections. The first illustration fig. 3-1 shows the AC powered version, and the second illustration fig. 3-2 shows the DC battery backup version. Both versions have identical connections for the External Probe, alarms, and both digital and analog concentration outputs. For detailed pinouts, see the wiring/interconnection drawings in the Drawings section at the rear of this manual.

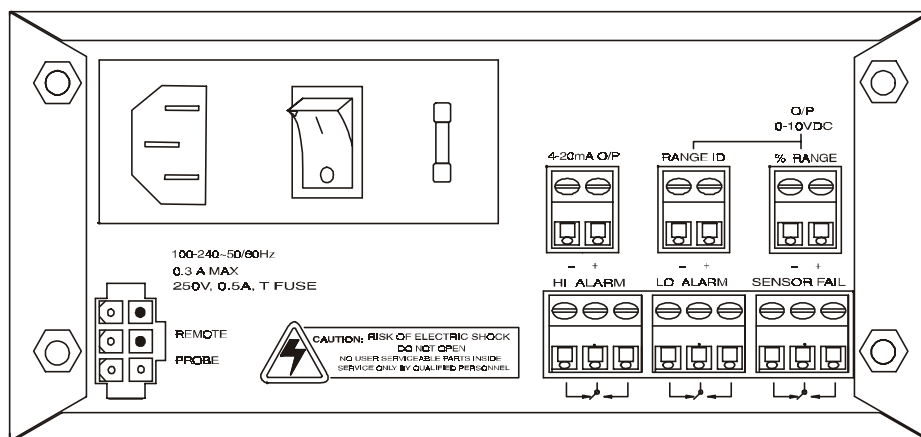

Figure 3-1 Electrical Connectors for AC Control Unit

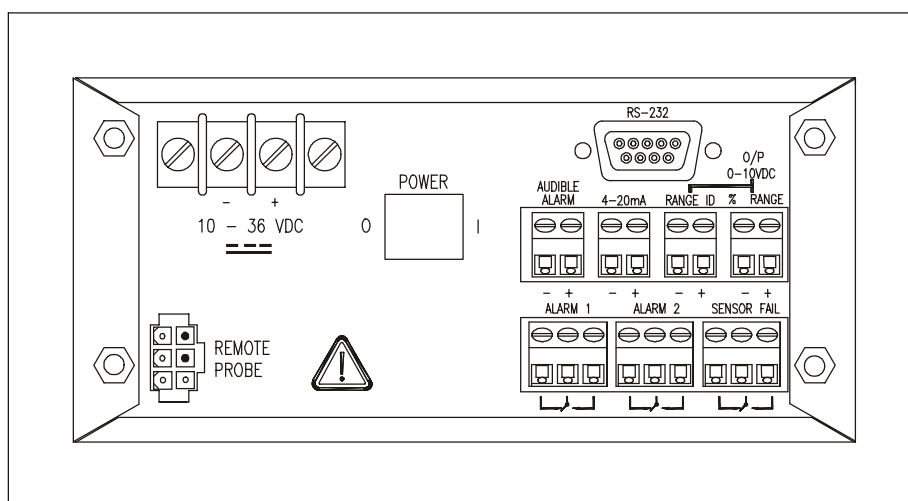

Figure 3-2 Electrical Connectors for DC Control Unit

3.5 Power and Signal Connections

AC and Battery Backed Standby Power

This 3350 is designed to operate from 100-240VAC @ 50/60 Hz power. Connect the included power cord to the AC power as shown in Fig. 3-3 for standard AC unit and Fig. 3-4 for battery backed standby power.

3.5.1 Primary Input Power (AC version): The power cord receptacle, fuse block and Power switch are on the Control Unit. A 6-foot, standard AC power cord is supplied with the analyzer.

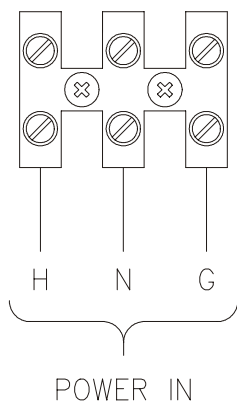

Figure 3-3 AC Input Power Connections

The universal power supply allows direct connection to any 100-240 VAC, 50/60Hz power source. The fuse block, to the right of the power cord receptacle, accepts two 5x20mm 0.5 A, 250V IEC type T fuse. (See *Fuse Replacement* in chapter 5, *Maintenance*.)

The Power switch is located on the right-hand end of the Control Unit power source input receptacle assembly.

3.5.2 Battery Backed Standby Power

An optional Battery Backed Standby Power Configuration is offered on the Model 3350 for potential power failure or "brown out" conditions. Power outages will not interfere with a properly-working Model 3350 oxygen alarm if it is installed and used correctly. The standby power source uses a rechargeable lead acid battery. If the AC power is temporarily impaired (“brown-out”) or interrupted, the stand-by power supply takes over and keeps the analyzer in operation.

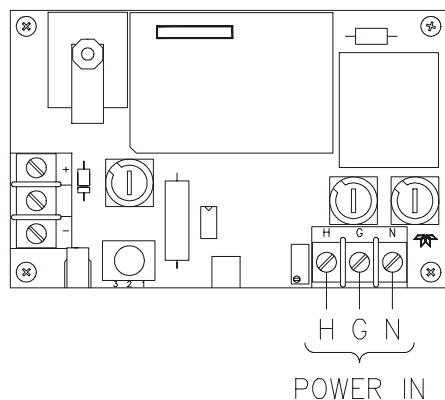

Figure 3-4 DC Battery Backup Input Power Connections

Periodically test the condition of the battery pack by pressing the "BATTERY TEST" pushbutton inside the instrument's control panel and note the battery condition by viewing the "battery low" LED on the front panel. Release the pushbutton to return to the normal sampling mode. The battery test provides only an indication of the battery state under the test conditions; it is possible that a battery might test well but perform for only a short time under actual operational conditions (a characteristic of the battery, not the analyzer), so it is very important that power outages be corrected without delay. Furthermore, TAI recommends that the instrument be tested periodically by operating it for several hours without AC power (that is, under battery power).

The optional battery backup version of the Model 3350 is designed to operate on standby battery power for at least 17 hours in Fail Safe mode and 48 hours in Non-Fail Safe mode (if conditions are favorable, i.e., conditions are not extreme and the battery is well charged and in good condition). Under actual conditions, however, these factors will always tend to evolve toward the worst case if left unattended. Therefore, the user must always ensure that battery condition, charge and other related factors are monitored with sufficient frequency to prevent problems. Most importantly, **DO NOT DEPEND UPON THE LONGEVITY OF BATTERY BACKUP**, but correct problems as soon as possible.

Battery service life depends on the number of discharge cycles, depth of discharge and ambient temperature.

Cycle service life in relation to depth of discharge:

- 180 cycles at 100% discharge
- 450 cycles at 50% discharge
- 1200 cycles at 30% discharge

The battery is designed for use in standby operation for approximately 3-5 years under normal service conditions. An ideal service condition will be realized when the battery is operated at an ambient temperature of 20°C (68°F). Operation of the battery at higher temperatures will reduce the battery life.

3.5.2.1 Connecting the Rechargeable Battery

Connect the battery as follows:

1. Slide "quick connect" lug attached to the black wire onto the negative (-) lug of the battery located closest to the opening of the enclosure.



Analog outputs should not be connected to any AC line source, or any source of hazardous voltages.

3.5.3 Analog Outputs

There are four DC output signal connectors with screw terminals on the panel. Recommended wire: 22 AWG minimum with 300VAC insulation. There are two wires per output with the polarity noted. The outputs are:

0–10 V % Range: Voltage rises with increasing oxygen concentration, from 0 V at 0 percent oxygen to 10 V at full scale percent oxygen. (Full scale = 25% O₂).

0–10 V Range ID: 03.33 V = Low Range, 06.66 V = High Range, 10 V = Air Cal Range.

4–20 mA % Range: Current increases with increasing oxygen concentration, from 4 mA at 0 percent oxygen to 20 mA at full scale percent oxygen. (Full scale = 25% O₂).

Audible Alarm: Factory installed to internal buzzer, may be used for customer interconnection to 12V a Buzzer (12-15VDC, 4.3mA Max.).



The RS232 terminals must not be connected to any AC line source, or any source of hazardous voltage.

3.5.4 RS-232 Port (Optional)

The digital signal output is a standard RS-232 serial communications port used to connect the analyzer to a computer, terminal, or other digital device. The pinouts are listed in Table 3-1.

Table 3-1: RS-232 Signals

RS-232 Sig	RS-232 Pin	Purpose
RD	2	Received Data
TD	3	Transmitted Data
COM	5	Common

The data sent is status information, in digital form, updated every two seconds. Status is reported in the following order:

- The concentration in percent
- The range in use

Each status output is followed by a carriage return and line feed.

The RS-232 protocol allows some flexibility in its implementation. Table 3-2 lists certain RS-232 values that are required by the 3350 implementation.

Table 3-2: Required RS-232 Options

Parameter	Setting
Baud	2400
Byte	8 bits
Parity	none
Stop Bits	1
Message Interval	2 seconds

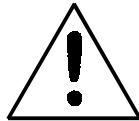

Alarm Relays must not be connected to any voltage source greater than 130VAC. Minimum recommended wire is 16 AWG with 300 VAC insulation

3.5.5 Alarm Relays

The three alarm-circuit connectors are screw terminals for making connections to internal alarm relay contacts. There is one set of contacts for each of 3 different types of alarm. Alarm 1 (CAUTION), Alarm 2 (DANGER), and Cell Fail. Contacts are Form C, with normally open and normally closed contact connections capable of switching up to 3 ampere at 130 VAC into a resistive load (3A for 30 VDC) maximum.

The alarm relay circuits are designed for failsafe operation, meaning the relays are energized during normal operation. If power fails the relays de-energize (alarms activated). Alarms are also available factory configured for non-failsafe operation which would extend the life of the battery standby power if applicable.

The contact connections are indicated diagrammatically on the rear panel as Normally Closed, Common, and Normally Open. Figure 3-5 explains how these act in failsafe operation.

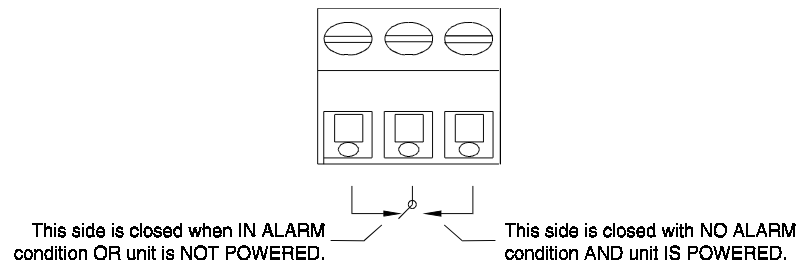

Figure 3-5: Contact ID for FAILSAFE Relay Operation

The specific descriptions for each type of alarm are as follows:

Alarm #1 (CAUTION) Factory preset for OSHA Standards at 20% Oxygen.

Alarm #2 (DANGER) Factory preset for OSHA Standards at 19.5% Oxygen.

Sensor Fail Actuates when the output of the Micro-Fuel Cell sensor falls below the acceptable level (0.05% Oxygen).

CAUTION: *There could be hazardous voltage at the alarms terminals, even when power is removed from the instrument.*



Internal Sensor Wiring: The receptacle for the sensor cable is located in the lower left-hand corner of the Control Unit rear panel. The 6-pin polarized connector is keyed to fit only one way into the receptacle. Do not force it in. The other end of the cable is connected to the top of the sensor in the sensor housing

3.6 Calibration

Prior to operating this instrument for the first time, the Oxygen Monitor must be calibrated. If this instrument is to be used as a safety monitor, routine calibration should be carried out on a weekly basis.

If it is not feasible to use ordinary air as the calibration gas, then clean, compressed instrument air can be used. It will probably be necessary to seal the sensor in the piped-in calibration gas to isolate it from the surrounding atmosphere. A flow-through adaptor can be purchased from TAI as an accessory for those applications. Although a special calibration gas can be used, the calibration results will be meaningless unless the oxygen concentration of the calibration gas is known, and the analyzer is adjusted to indicate that concentration. To eliminate any error caused by the calibration gas, always use a certified composition with an oxygen concentration between 80% and 90% of the full scale meter reading of the analyzer.

NOTE: *Calibration in the same atmosphere that is being monitored can result in serious error. The analysis performed and the alarms, if any, generated by this instru-*

ment when calibrated using the monitored atmosphere or a span gas of unknown composition, will be meaningless.

Preliminary—If not already done: Power up the Analyzer and allow the LED reading to stabilize.

Procedure:

1. Expose the sensor to ambient air or instrument grade air (20.9% oxygen). Allow time for the analyzer to achieve equilibrium.
2. Press the SPAN button once.
3. Immediately (within 5 seconds) press either the Δ or ∇ button until the display is stable and reads 20.9%.

The unit is now calibrated. (also see section 4 operation)

Note: The alarms will be disabled for about 25 seconds after the SPAN button is released. Disabling the alarms allows air to be cleared from the sensor without tripping any alarm set below span (20.9%).

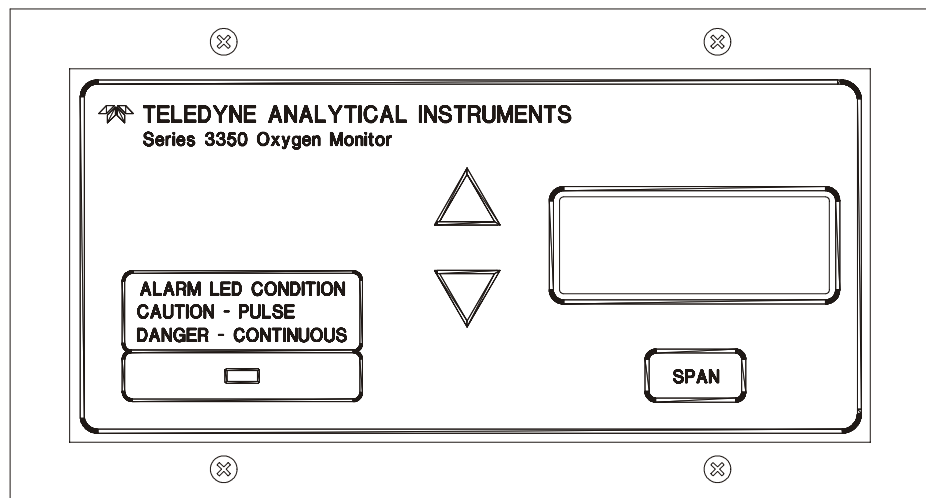

Figure 3-6 Front Panel Membrane (Control Unit)

3.7 Operation

Once the instrument has been installed, calibrated, and the power turned on, it will continuously monitor the oxygen level within the environment it is placed. The oxygen level is displayed on the digital meter. The response time of the instrument will depend on the actual Micro-Fuel Cell (MFC) installed. With the class B-3 MFC installed, the response time is less than 15 seconds at 25°C. The table below indicates the response time for some MFCs typically used in the Model 3350.

Class	Response Time (Sec)	Warranty (Months)	Application
B-3	13	12	Intermediate response/long life

3.8 Cell Warranty

The Class B-3 cell used in the Model 3350 is warranted for 12 months of service. Under normal operating conditions the Class B-3 cell should last 12 months in air. For special applications, optional cells are available.

Customers having warranty claims must return the cell in question to the factory for evaluation after obtaining an RMA number. If it is determined that failure is due to faulty workmanship or materials, the cell will be replaced free of charge. If a cell was working satisfactorily, but fails short of its warranty period, the customer will receive credit, on a prorated basis, toward the purchase of a new cell.

NOTE: *Evidence of mishandling will render the cell warranty null and void.*

3.9 Safety Checklist

The following checklist is offered only as a guide to assist the user in verifying a number of important factors; it is by no means a complete list of safety-related items. The procedures and precautions relating to the use of the instrument in the user's process must be developed by the user. It is vital that the operator understand and test the operation of the total system.

Verify:

1. Instrument power is active and adequate.
2. Instrument functions are operational.
3. Alarm indicators are effective and produce intended results.
4. Unauthorized personnel are prevented from tampering with the instrument or auxiliary equipment.
5. Routine test and calibration procedures are instituted and followed.
6. Any and all sampling and/or location problems are identified and handled.

7. Any and all necessary warning labels, notices, and information are provided.
8. Operators understand the operations and functions of the analyzer and system.
9. Any environmental or other influences that could affect the operation or accuracy of the instrument are identified and handled.

3.10 Accessory Flow-Through Adapter

A flow-through adaptor is available for the Series 3350 Oxygen Analyzer for those applications that require piped-in gases (TAI P/N A9226). The adaptor consists of a sealed chamber where the instrument's probe is inserted, with two radially-oriented hose connectors to which supply and vent lines for the calibration gas are connected. The design provides gas flow over the sensing surface of the cell without contamination by the surrounding monitored atmosphere.

Operation

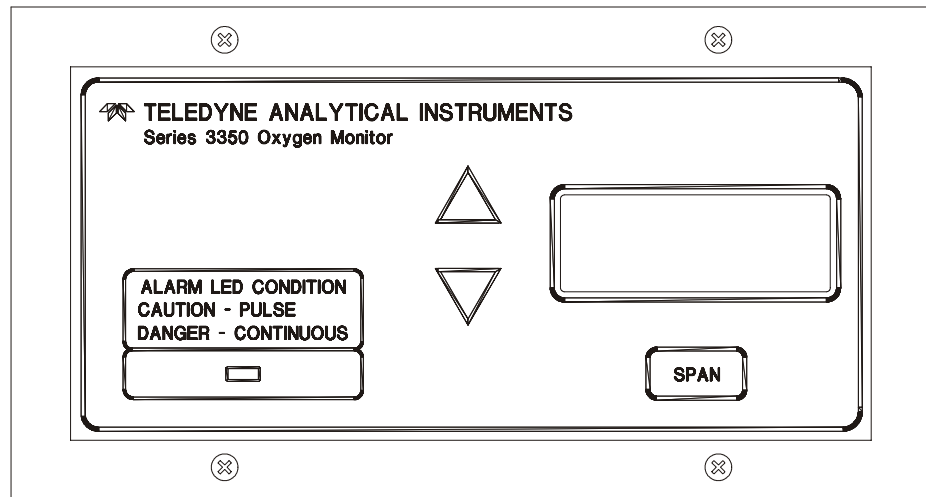

Figure 4-1 Front Panel Membrane (Control Unit)

4.1 Using the Span and Data Entry Buttons

When no buttons on the Analyzer are being pressed, the instrument is in the Analyze mode. It is monitoring the percent of oxygen that is flowing around the Probe.

When one of the Function Buttons is being pressed, the Analyzer is in the Setup mode or the Calibration mode.

The Calibration mode button is:

- **SPAN**

The Data Entry buttons (Δ and ∇) increment the values displayed on the PERCENT OXYGEN meter while one of the Function buttons is being held down.

- Δ : Increments the displayed value upwards.
- ∇ : Increments the displayed value downwards.

The Span function can be selected at any time by holding down the appropriate button.

4.2 Alarm Conditions

The alarm setpoints are preset at the factory and can not be changed by the user.

Alarm 1 (CAUTION)

Factory preset at 20% Oxygen. Contact factory for custom Alarm Setpoints.

When CAUTION Alarm (Alarm 1) is activated, the LED on the front panel will begin to blink. In addition, the digital readout will flash alternately with the oxygen reading and the letters “CAUt” for CAUTION.

Alarm 2 (DANGER)

Factory preset at 19.5% Oxygen per OSHA Specification. Contact factory for custom Alarm Setpoints.

When DANGER Alarm (Alarm 2) is activated, the LED on the front panel stay on continuously. In addition, the digital readout will flash alternately with the oxygen reading and the letters “dAng” for DANGER.

Sensor Fail Alarm

The SENSOR FAIL alarm is factory set to a reading less than 0.05% O₂. Should this alarm trigger the ALARM Indicator below the SET Function buttons will blink, and the alarm relay contact dedicated to this function will change state.

4.3 Calibration

Prior to operating this instrument for the first time, the Oxygen Monitor must be calibrated. If this instrument is to be used as a safety monitor, routine calibration should be carried out on a weekly basis.

If it is not feasible to use ordinary air as the calibration gas, then clean, compressed instrument air can be used. It will probably be necessary to seal the sensor in the piped-in calibration gas to isolate it from the surrounding atmosphere. A flow-through adaptor can be purchased from TAI as an accessory for those applications. Although a special calibration gas can be used, the calibration results will be meaningless unless the oxygen concentration of the calibration gas is known, and the analyzer is adjusted to indicate

that concentration. To eliminate any error caused by the calibration gas, always use a certified composition with an oxygen concentration between 80% and 90% of the full scale meter reading of the analyzer.

CAUTION: *Calibration in the same atmosphere that is being monitored can result in serious error. The analysis performed and the alarms, if any, generated by this instrument when calibrated using the monitored atmosphere or a span gas of unknown composition, will be meaningless.*

Preliminary—If not already done: Power up the Analyzer and allow the LED reading to stabilize.

Procedure:

1. Expose the sensor to ambient air or instrument grade air (20.9% oxygen). Allow time for the analyzer to achieve equilibrium.

Note: **If the analyzer goes overrange, the display will go blank and the front panel ALARM Indicator, beneath the SET Function buttons, will blink. Hold down the SPAN button until the ALARM Indicator stops blinking.**

2. Press the SPAN button once.
3. Immediately (within 5 seconds) press either the Δ or ∇ button until the display is stable and reads 20.9%.

Note: **When an arrow button is first pressed, the LED begins flashing slightly more rapidly and no longer tracks the span gas. Instead, it responds to the UP/DOWN keystrokes.**

Note: **While the LED is flashing slightly more rapidly, the SPAN routine will time-out in five seconds (instead of five minutes), if no further keystrokes are entered.**

4. When the span value is set to 20.9% Oxygen, stop pressing the keys and wait for five seconds.

The unit is now calibrated. (also see section 4 operation)

Note: **The alarms will be disabled for about 25 seconds after the SPAN button is released. Disabling the alarms allows air to be cleared from the sensor without tripping any alarm set below span (20.9%).**

Supplementary Information

If, during the Span Procedure, you pressed the SPAN button by mistake, you must wait five minutes for the analyzer to resume analysis or you can press the UP button and then the DOWN button. (Pressing the UP and DOWN buttons causes the analyzer to time-out in five seconds instead of five minutes).

Maintenance

Aside from normal cleaning, the Model 3350 should not require any maintenance beyond replacement of expended Micro-Fuel Cells, and perhaps a blown fuse. Routine maintenance includes occasional recalibration, as described in chapter 4, *Operation*.



5.1 Replacing the Fuses

Remove Power to Unit before replacing any fuse.

The Model 3350 has two different configurations: Standard AC Version and AC with Battery Backup Version. Both configurations have replaceable fuses. When a fuse blows, check first to determine the cause, then replace the fuse(s) using the following procedures, depending on which version is used.

5.1.1 Standard AC Version

When a fuse blows, check first to determine the cause, then replace the fuse using the following procedure:

1. Disconnect the AC power and place the power switch located on the rear panel of the control unit in the **O** position. Remove the control unit power cord from the receptacle.
2. The fuse receptacle is located in the power cord receptacle assembly in the upper left-hand corner of the control unit, on the front door. See Figure 5-1.

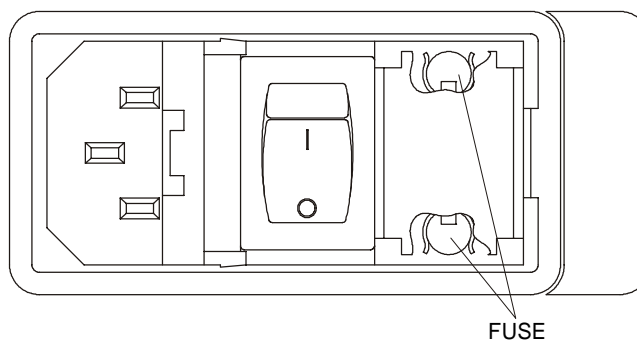

Figure 5-1: AC Fuse Replacement

3. Insert a small flat-blade screwdriver into the slot in the receptacle at the end of the power module and gently pry open the fuse receptacle. The fuse holder will slide out. There are two fuses in use and are visible in the clip.
4. Remove the bad fuse and replace it with a 5x20mm 0.5 A, 250 VAC, type T fuse(P/N F1130).
5. Replace the fuse holder into its receptacle, pushing in firmly until it clicks.

5.1.2 AC With Battery Backup Version

1. Disconnect the AC power and place the power switch, located on the rear panel of the control unit, in the **O** position.
2. Place a small screwdriver in the notch of the fuse holder cap, push in and rotate 1/4 turn. The cap will pop out a few millimeters. Pull out the fuse holder cap and fuse, as shown in figure 5-2.

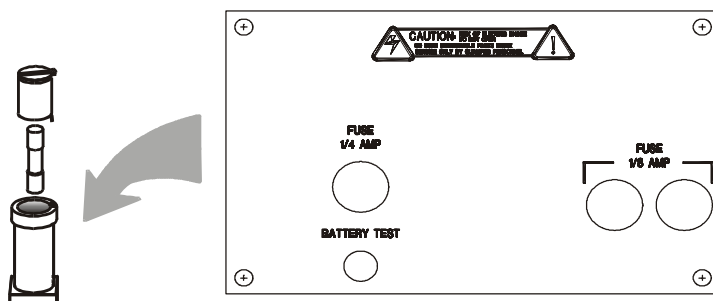

Figure 5-2: DC Battery Backup Fuse Replacement

3. Replace fuse by reversing process in step 1.

5.2 Sensor Installation or Replacement

5.2.1 When to Replace a Sensor

The Micro-Fuel Cell typically provide almost constant output through their useful life, and then fall off sharply towards zero at the end. You will find that very little adjustment will be required to keep the analyzer calibrated properly during the duration of a given cell's useful life.

If large adjustments are required to calibrate the instrument, or calibration cannot be achieved within the range of the Δ buttons, the cell may need replac-

ing. Read the section *Cell Warranty Conditions*, below, before replacing the cell.

In addition, if the front panel Percent Oxygen Meter displays “00.0” when the unit is plugged in, and the power switch is in the ON position, the sensor needs to be replaced.

IMPORTANT: After replacing the Micro-Fuel Cell, the analyzer must be recalibrated. See *Calibration* in chapter 4.

5.2.2 Ordering and Handling of Spare Sensors

To have a replacement cell available when it is needed, TET/AI recommends that one spare cell be purchased shortly after the instrument is placed in service, and each time the cell is replaced.

CAUTION: Do not stockpile cells. The warranty period starts on the day of shipment. For best results, order a new spare cell when the current spare is installed.

The spare cell should be carefully stored in an area that is not subject to large variations in ambient temperature (75° F nominal), and in such a way as to eliminate the possibility of incurring damage.

CAUTION: Do not disturb the integrity of the cell package until the cell is to actually be used. If the cell package is punctured and air is permitted to enter, cell-life will be compromised.

WARNING: The sensor used in the Model 3350 uses electrolytes which contain substances that are extremely harmful if touched, swallowed, or inhaled. Avoid contact with ANY fluid or powder in or around the unit. What may appear to be plain water could contain one of these toxic substances. In case of eye contact, immediately flush eyes with water for at least 15 minutes. Call physician. (See Appendix, Material Safety Data Sheet—MSDS).



5.2.3 Removing the Micro-Fuel Cell

To remove a spent or damaged Micro-Fuel Cell:

1. Disconnect the Power Source from the Unit.
2. Remove the spent cell by unscrewing it, counterclockwise, from the cell holder.
3. Dispose of the cell in a safe manner, and in accordance with local laws.

5.2.4 Installing a Micro-Fuel Cell

To install a new Micro-Fuel Cell:

CAUTION: Do not scratch, puncture, or damage the sensing membrane of the Micro-Fuel Cell sensor. Damage to the membrane will require replacement of the sensor.

To install the new cell:

1. Remove probe assembly from the probe holder.
2. Unscrew the cap from the top of the probe assembly.
3. Place the cell in the probe with the terminal end of the cell facing down towards the probe contacts.
4. Replace the probe cap.

5.2.5 Cell Warranty Conditions

The Class B-3 Micro-Fuel cell is used in the Model 3350. This cell is a long life cell and is warranted for 1 year (under specified operating conditions—see Appendix) from the date of shipment. Note any Addenda attached to the front of this manual for special information applying to your instrument.

With regard to spare cells, warranty period begins on the date of shipment. The customer should stock only one spare cell per instrument at a time. Do not attempt to stockpile spare cells.

If a cell was working satisfactorily, but ceases to function before the warranty period expires, the customer will receive credit toward the purchase of a new cell.

If you have a warranty claim, you must return the cell in question to the factory for evaluation. If it is determined that failure is due to faulty workmanship or material, the cell will be replaced at no cost to the customer.

NOTE: Evidence of damage due to tampering or mishandling will render the cell warranty null and void.

Appendix

A.1 Specifications

Range:	0-25% Oxygen
Sensitivity:	0.5% of full scale
Accuracy:	±2% of full scale (at constant temperature) ±5% of full scale (over operating temperature range once the system has reached equilibrium)
Response Time:	90% in less than 20 seconds at 25°C (B-3 cell)
Operating, and Storage Temperature:	0-50°C
Relative Humidity:	0-95% Non condensing
Maximum Altitude:	6562ft (2000 meters)
Reproducibility:	± 1% of full scale
Sensor Type:	B-3
Display:	Light emitting diode display - LED.
Battery Life:	48 hours (non-alarm condition) non-failsafe 17 hours (non-alarm conditions) failsafe
Power Requirements:	AC 100 to 240VAC @ 50/60 Hz, 0.3A MAX Battery Backup version charges and maintains a 12 VDC lead acid battery.
Signal Output:	Voltage: 0-10 VDC, Negative Ground (10mA MAX) Current: 4-20 mA, Negative Ground (15V MAX open circuit) 10VDC/500ohms maximum operating range.
Audible Alarm:	12-15 VDC 4.3mA Max.
Range ID:	0-10VDC (0-10mA MAX) (80mA short circuit)
Enclosure:	Wall Mounting, NEMA-4 enclosure. Approx. 8"(W) x 10"(H) x 6"(D)
Alarms:	Factory Set: CAUTION = 20.0% DANGER = 19.5% CELL FAIL

Audible Buzzer
Visual Red, Indicator Lamps

A.2 Spare Parts List

Standard AC Version

QTY.	P/N	DESCRIPTION
1	C-65220G	PC Board, Main
1	C-70740A	PC Board, Power Supply AC Version
1	C-70875	Probe Assembly
1	C-800	Probe Clip
4	F-1130	Fuse (AC), 1/2A, 250 VAC IEC Type T
1	A-20	Alarm, Audible
1	C-6689	Micro-Fuel Cell, Class B-3 (if non-standard, see "Specifications" sheet)
1	A-74345	Flow thru adapter

Battery Backup Version

QTY.	P/N	DESCRIPTION
1	C-70724	Battery Charger BD.
1	C-70740B	PC Board, Power Supply, DC Version
2	F-1127	Fuse 1/8 A, IEC Type T 250VAC
4	F-1128	Fuse 1/4 A, IEC Type T 250VAC
1	B-500	Battery, 12VDC, 7Ah

IMPORTANT: Orders for replacement parts should include the part number and the model and serial number of the system for which the parts are intended.

Send orders to:

TELEDYNE ELECTRONIC TECHNOLOGIES

Analytical Instruments

16830 Chestnut Street

City of Industry, CA 91749-1580

Telephone: (626) 934-1500

TWX: (910) 584-1887 TDYANYL COID

Fax: (626) 961-2538

or your local representative.

A.3 Reference Drawings

D-70682 Final Assembly
D-70679 Outline Diagram
D-70680 Interconnection Diagram

A.4 Miscellaneous

The symbol: ~ is used on the rear of the control panel of the model 3350 to signify volts alternating current (V ac).

NOTE: The MSDS on this material is available upon request through the Teledyne Environmental, Health and Safety Coordinator. Contact at (626) 934-1592



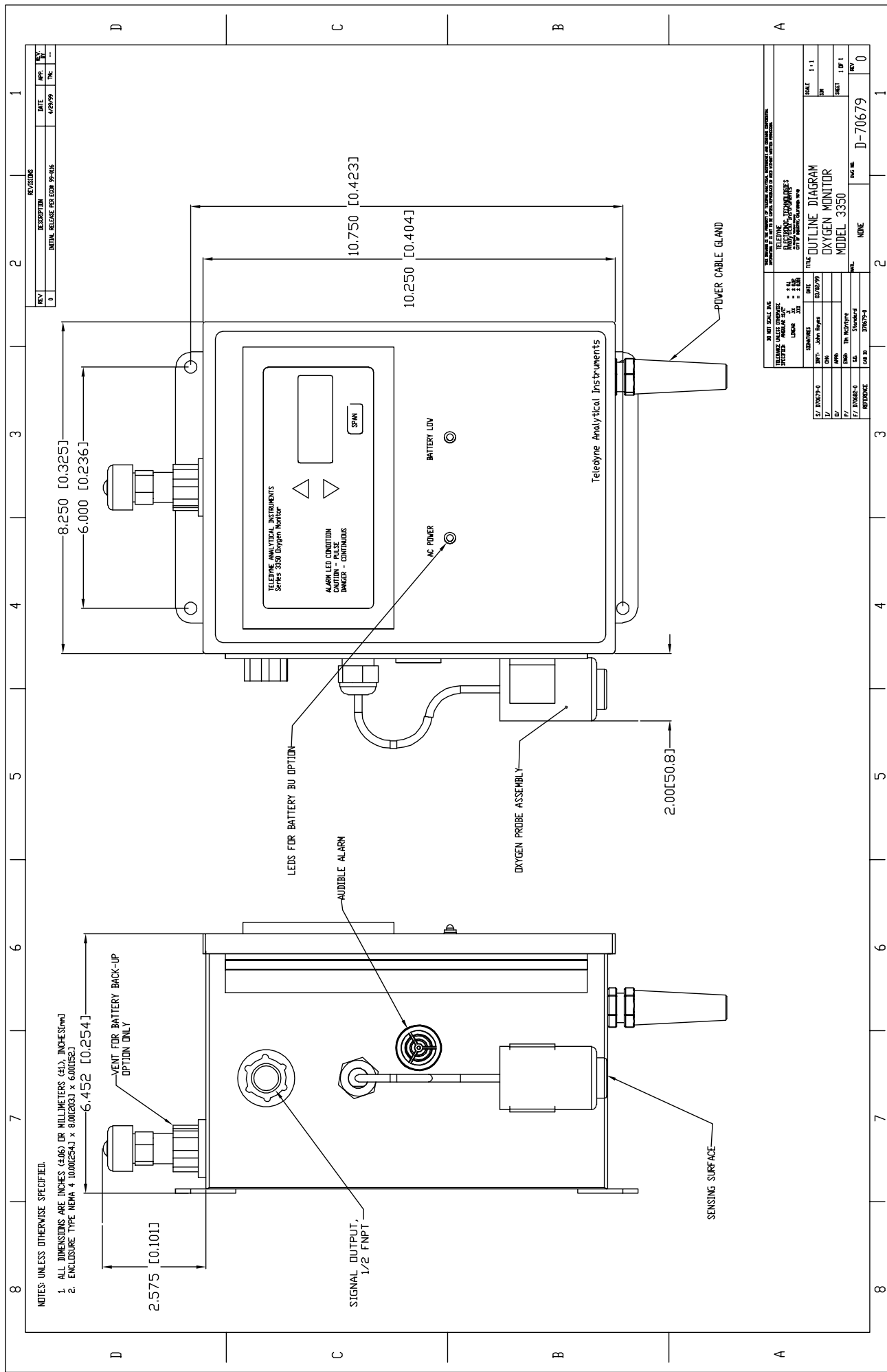

NOTES: UNLESS OTHERWISE SPECIFIED:

1. ALL DIMENSIONS ARE INCHES (±0.06) OR MILLIMETERS (±0.1), UNLESS SHOWN OTHERWISE.
2. ENCLOSURE TYPE NEMA 4 (10.000254J x 9.000203J x 6.000152J)

REV	DESCRIPTION	DATE	APP'D	BY
0	INITIAL RELEASE PER ESDS 99-4065	4/29/99		

TELETYPE ANALYTICAL INSTRUMENTS		TELETYPE ANALYTICAL INSTRUMENTS	
REV	DESCRIPTION	DATE	APP'D
0	INITIAL RELEASE PER ESDS 99-4065	4/29/99	

SYNOPSIS	DATE	SCALE
DWG NO. D-70679-3	03/02/99	1:1
DESIGNER	CHKD	DRW
BY: John Rogers		
APP'D	IN CHARGE	SHEET
BY: [Signature]		1 OF 1
DATE	SCALE	REV
03/02/99		0

TITLE	OUTLINE DIAGRAM
DESCRIPTION	DXYGEN MONITOR
MODEL	MODEL 3350
DATE	03/02/99
SCALE	1:1
DWG NO.	D-70679-3
REV	0

REVISIONS			
REV	DESCRIPTION	DATE	APP. REV.
1	INC. ECO 99-0378	9-20-99	RF MW
2	INC. ECO 00-0022	1/21/00	AA DC

NOTES: UNLESS OTHERWISE SPECIFIED,
 ① THE GN/YL WIRE MUST BE 1" LONGER THAN THE BLUE OR BROWN WIRES.
 ② FOR PERMANENT INSTALLATION 16 AWG (MIN.) 250 VAC RATED WIRE IS RECOMMENDED.

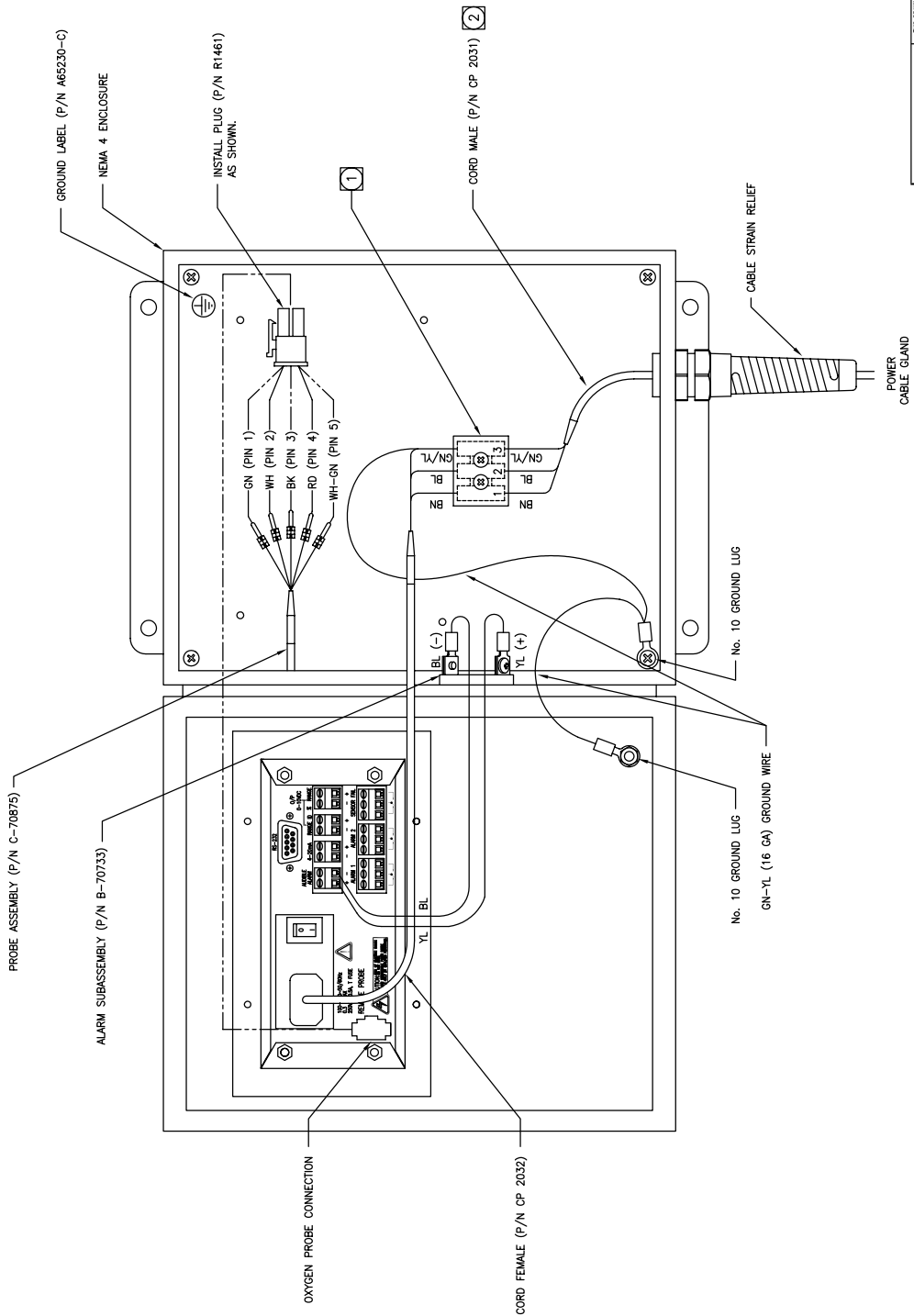

DIS NOT SCALE DIMS			
TOLERANCES UNLESS OTHERWISE SPECIFIED: ANGULAR ±1/2°			
LINEAR: .0005" - .001" = F.02			
.001" - .005" = .0005"			
.005" - .010" = .001"			
.010" - .030" = .002"			
.030" - .050" = .005"			
.050" - .100" = .010"			
.100" - .300" = .020"			
.300" - .500" = .030"			
.500" - 1.000" = .040"			
1.000" - 2.000" = .050"			
2.000" - 5.000" = .060"			
5.000" - 10.000" = .070"			
10.000" - 25.000" = .080"			
25.000" - 50.000" = .090"			
50.000" - 100.000" = .100"			
100.000" - 250.000" = .120"			
250.000" - 500.000" = .150"			
500.000" - 1000.000" = .200"			
1000.000" - 2500.000" = .250"			
2500.000" - 5000.000" = .300"			
5000.000" - 10000.000" = .375"			
10000.000" - 25000.000" = .450"			
25000.000" - 50000.000" = .500"			
50000.000" - 100000.000" = .600"			
100000.000" - 250000.000" = .750"			
250000.000" - 500000.000" = .900"			
500000.000" - 1000000.000" = 1.000"			
1000000.000" - 2500000.000" = 1.250"			
2500000.000" - 5000000.000" = 1.500"			
5000000.000" - 10000000.000" = 1.750"			
10000000.000" - 25000000.000" = 2.000"			
25000000.000" - 50000000.000" = 2.250"			
50000000.000" - 100000000.000" = 2.500"			
100000000.000" - 250000000.000" = 2.750"			
250000000.000" - 500000000.000" = 3.000"			
500000000.000" - 1000000000.000" = 3.250"			
1000000000.000" - 2500000000.000" = 3.500"			
2500000000.000" - 5000000000.000" = 3.750"			
5000000000.000" - 10000000000.000" = 4.000"			
10000000000.000" - 25000000000.000" = 4.250"			
25000000000.000" - 50000000000.000" = 4.500"			
50000000000.000" - 100000000000.000" = 4.750"			
100000000000.000" - 250000000000.000" = 5.000"			
250000000000.000" - 500000000000.000" = 5.250"			
500000000000.000" - 1000000000000.000" = 5.500"			
1000000000000.000" - 2500000000000.000" = 5.750"			
2500000000000.000" - 5000000000000.000" = 6.000"			
5000000000000.000" - 10000000000000.000" = 6.250"			
10000000000000.000" - 25000000000000.000" = 6.500"			
25000000000000.000" - 50000000000000.000" = 6.750"			
50000000000000.000" - 100000000000000.000" = 7.000"			
100000000000000.000" - 250000000000000.000" = 7.250"			
250000000000000.000" - 500000000000000.000" = 7.500"			
500000000000000.000" - 1000000000000000.000" = 7.750"			
1000000000000000.000" - 2500000000000000.000" = 8.000"			
2500000000000000.000" - 5000000000000000.000" = 8.250"			
5000000000000000.000" - 10000000000000000.000" = 8.500"			
10000000000000000.000" - 25000000000000000.000" = 8.750"			
25000000000000000.000" - 50000000000000000.000" = 9.000"			
50000000000000000.000" - 100000000000000000.000" = 9.250"			
100000000000000000.000" - 250000000000000000.000" = 9.500"			
250000000000000000.000" - 500000000000000000.000" = 9.750"			
500000000000000000.000" - 1000000000000000000.000" = 10.000"			
1000000000000000000.000" - 2500000000000000000.000" = 10.250"			
2500000000000000000.000" - 5000000000000000000.000" = 10.500"			
5000000000000000000.000" - 10000000000000000000.000" = 10.750"			
10000000000000000000.000" - 25000000000000000000.000" = 11.000"			
25000000000000000000.000" - 50000000000000000000.000" = 11.250"			
50000000000000000000.000" - 100000000000000000000.000" = 11.500"			
100000000000000000000.000" - 250000000000000000000.000" = 11.750"			
250000000000000000000.000" - 500000000000000000000.000" = 12.000"			
500000000000000000000.000" - 1000000000000000000000.000" = 12.250"			
1000000000000000000000.000" - 2500000000000000000000.000" = 12.500"			
2500000000000000000000.000" - 5000000000000000000000.000" = 12.750"			
5000000000000000000000.000" - 10000000000000000000000.000" = 13.000"			
10000000000000000000000.000" - 25000000000000000000000.000" = 13.250"			
25000000000000000000000.000" - 50000000000000000000000.000" = 13.500"			
50000000000000000000000.000" - 100000000000000000000000.000" = 13.750"			
100000000000000000000000.000" - 250000000000000000000000.000" = 14.000"			
250000000000000000000000.000" - 500000000000000000000000.000" = 14.250"			
500000000000000000000000.000" - 1000000000000000000000000.000" = 14.500"			
1000000000000000000000000.000" - 2500000000000000000000000.000" = 14.750"			
2500000000000000000000000.000" - 5000000000000000000000000.000" = 15.000"			
5000000000000000000000000.000" - 10000000000000000000000000.000" = 15.250"			
10000000000000000000000000.000" - 25000000000000000000000000.000" = 15.500"			
25000000000000000000000000.000" - 50000000000000000000000000.000" = 15.750"			
50000000000000000000000000.000" - 100000000000000000000000000.000" = 16.000"			
100000000000000000000000000.000" - 250000000000000000000000000.000" = 16.250"			
250000000000000000000000000.000" - 500000000000000000000000000.000" = 16.500"			
500000000000000000000000000.000" - 1000000000000000000000000000.000" = 16.750"			
1000000000000000000000000000.000" - 2500000000000000000000000000.000" = 17.000"			
2500000000000000000000000000.000" - 5000000000000000000000000000.000" = 17.250"			
5000000000000000000000000000.000" - 10000000000000000000000000000.000" = 17.500"			
10000000000000000000000000000.000" - 25000000000000000000000000000.000" = 17.750"			
25000000000000000000000000000.000" - 50000000000000000000000000000.000" = 18.000"			
50000000000000000000000000000.000" - 100000000000000000000000000000.000" = 18.250"			
100000000000000000000000000000.000" - 250000000000000000000000000000.000" = 18.500"			
250000000000000000000000000000.000" - 500000000000000000000000000000.000" = 18.750"			
500000000000000000000000000000.000" - 1000000000000000000000000000000.000" = 19.000"			
1000000000000000000000000000000.000" - 2500000000000000000000000000000.000" = 19.250"			
2500000000000000000000000000000.000" - 5000000000000000000000000000000.000" = 19.500"			
5000000000000000000000000000000.000" - 10000000000000000000000000000000.000" = 19.750"			
10000000000000000000000000000000.000" - 25000000000000000000000000000000.000" = 20.000"			
25000000000000000000000000000000.000" - 50000000000000000000000000000000.000" = 20.250"			
50000000000000000000000000000000.000" - 100000000000000000000000000000000.000" = 20.500"			
100000000000000000000000000000000.000" - 250000000000000000000000000000000.000" = 20.750"			
250000000000000000000000000000000.000" - 500000000000000000000000000000000.000" = 21.000"			
500000000000000000000000000000000.000" - 1000000000000000000000000000000000.000" = 21.250"			
1000000000000000000000000000000000.000" - 2500000000000000000000000000000000.000" = 21.500"			
2500000000000000000000000000000000.000" - 5000000000000000000000000000000000.000" = 21.750"			
5000000000000000000000000000000000.000" - 10000000000000000000000000000000000.000" = 22.000"			
10000000000000000000000000000000000.000" - 25000000000000000000000000000000000.000" = 22.250"			
25000000000000000000000000000000000.000" - 50000000000000000000000000000000000.000" = 22.500"			
50000000000000000000000000000000000.000" - 100000000000000000000000000000000000.000" = 22.750"			
100000000000000000000000000000000000.000" - 250000000000000000000000000000000000.000" = 23.000"			
250000000000000000000000000000000000.000" - 500000000000000000000000000000000000.000" = 23.250"			
500000000000000000000000000000000000.000" - 1000000000000000000000000000000000000.000" = 23.500"			
1000000000000000000000000000000000000.000" - 2500000000000000000000000000000000000.000" = 23.750"			
2500000000000000000000000000000000000.000" - 5000000000000000000000000000000000000.000" = 24.000"			
5000000000000000000000000000000000000.000" - 10000000000000000000000000000000000000.000" = 24.250"			
10000000000000000000000000000000000000.000" - 25000000000000000000000000000000000000.000" = 24.500"			
25000000000000000000000000000000000000.000" - 50000000000000000000000000000000000000.000" = 24.750"			
50000000000000000000000000000000000000.000" - 100000000000000000000000000000000000000.000" = 25.000"			
100000000000000000000000000000000000000.000" - 250000000000000000000000000000000000000.000" = 25.250"			
250000000000000000000000000000000000000.000" - 500000000000000000000000000000000000000.000" = 25.500"			
500000000000000000000000000000000000000.000" - 1000000000000000000000000000000000000000.000" = 25.750"			
1000000000000000000000000000000000000000.000" - 2500000000000000000000000000000000000000.000" = 26.000"			
2500000000000000000000000000000000000000.000" - 5000000000000000000000000000000000000000.000" = 26.250"			
5000000000000000000000000000000000000000.000" - 100.000" = 26.500"			
100.000" - 25000000000000000000000000000000000000000.000" = 26.750"			
25000000000000000000000000000000000000000.000" - 500.000" = 27.000"			
500.000" - 1000.000" = 27.250"			
1000.000" - 2500.000" = 27.500"			
2500.000" - 5000.000" = 27.750"			
5000.000" - 100.000" = 28.000"			
100.000" - 25000.000" = 28.250"			
25000.000" - 500.000" = 28.500"			
500.000" - 1000.000" = 28.750"			
1000.000" - 2500.000" = 29.000"			
2500.000" - 5000.000" = 29.250"			
5000.000" - 100.000" = 29.500"			
100.000" - 25000.000" = 29.750"			
25000.000" - 500.000" = 30.000"			
500.000" - 1000.000" = 30.250"			
1000.000" - 2500.000" = 30.500"			
2500.000" - 5000.000" = 30.750"			
500000			

REV	DESCRIPTION	DATE	APP.	REV.
2	INC PEE ECDF 00-0340	06/19/00	SB	1
3	INC PEE ECDF 01-0377			3

NOTES: UNLESS OTHERWISE SPECIFIED.

1. OPTIONS: A - MODEL 3350 AC VERSION
 B - MODEL 3350 AC VERSION (BATTERY BACK-UP)
 C - MODEL 3350 AC VERSION WITH RS232
 D - MODEL 3350 VERSION WITH RS232 (BATTERY BACK-UP)

2. FOR WIRING SEE DRAWING No. D-70680-A (AC VERSION)
 OR D-70680-B (DC VERSION).

3. FOR INSTALLATION OF ITEMS SEE WIRING DIAGRAM.

4. USE LOCTITE ON SCREWS TO SEAL HOLES.
5. CUT TO LENGTH AS SHOWN INSTALL UNDER TERMINAL STRIP.
6. INSTALL TAG ON INTERIOR AND EXTERIOR OF CASE.
7. APPLY 1/2" TEFLON TAPE TO THREADS OF ITEM 42.

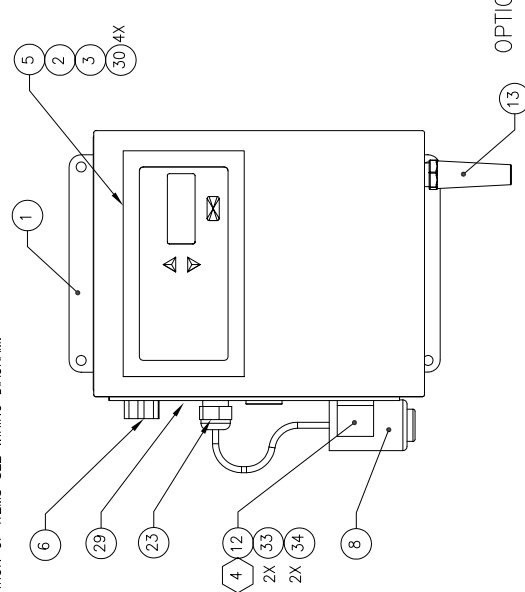

OPTIONS A & C

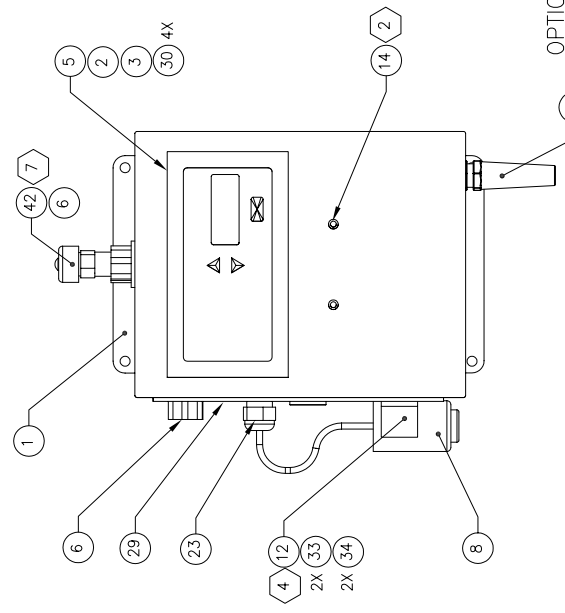

OPTIONS B & D

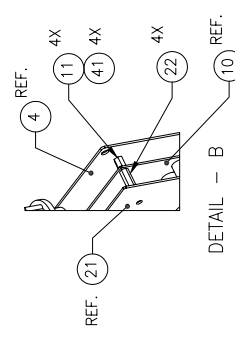

DETAIL - B

ITEM	QTY.	QTY.	QTY.	QTY.	DESCRIPTION
A	B	C	D		
1	0	0	0	0	CASE SUBSCREEN (AC VERSION)
2	1	1	1	1	CASE SUBSCREEN (BATTERY BACK-UP)
3	1	1	1	1	CASE SUBSCREEN (AC VERSION WITH RS232)
4	1	1	1	1	GASKET ORG THICK ADHESIVE BACK
5	1	0	0	0	MOUNTING PLATE FABRICATION DETAIL
6	0	1	0	0	CONTROL UNIT ASSY (AC VERSION)
7	0	0	1	0	CONTROL UNIT ASSY (BATTERY BACK-UP)
8	0	0	1	0	CONTROL UNIT ASSY (AC/RS232-VER)
9	0	0	1	0	CONTROL UNIT ASSY (BATTERY./RS232-VER)
10	1	1	1	1	HUB, 1/2" FNPT
11	1	1	1	1	ALARM SUBASSEMBLY
12	1	1	1	1	OXYGEN PROBE ASSEMBLY
13	1	1	1	1	BATTERY
14	1	1	1	1	BATTERY CHARGER BOARD
15	1	1	1	1	SPACER, No. 6 x .375 LG. HEX
16	1	1	1	1	CLIP, PROBE ASSEMBLY
17	1	1	1	1	STRAP FABRICATION DETAIL
18	1	1	1	1	BATTERY CABLE ASSEMBLY
19	1	1	1	1	TERMINAL BLOCK
20	1	1	1	1	MARKER PLATE
21	0	1	0	1	CUSTOMER INTERFACE PANEL
22	0	4	0	4	SPACER, No. 6 x .100 LG. F/F HEX STSIL
23	1	1	1	1	FITTING, LIQUID TIGHT M/CSEA
24	1	1	1	1	CONNECTOR, PLUG 6 POINTS
25	1	1	1	1	CORD, MALE
26	1	0	1	0	CORD, FEMALE
27	2	2	2	2	LABEL DETAIL, MODEL NUMBER
28	1	0	1	0	LABEL DETAIL, POWER ID
29	1	1	1	1	LABEL DETAIL, SIGNAL OUTPUT
30	A/R	A/R	A/R	A/R	SCREW, No. 4-40 x .50 LG. FLT. HD.
31	A/R	A/R	A/R	A/R	SCREW, No. 6-32 x .375 LG. BND. HD.
32	A/R	A/R	A/R	A/R	LOCKWASHER, No. 6 EXTERNAL TOOTH
33	A/R	A/R	A/R	A/R	SCREW, No. 6-32 x .50 LG. BND. HD.
34	A/R	A/R	A/R	A/R	SCREW, No. 6-32 x .375 LG. BND. HD.
35	A/R	A/R	A/R	A/R	LOCKWASHER, No. 8 EXTERNAL TOOTH
36	A/R	A/R	A/R	A/R	SCREW, No. 8-32 x .50 LG. BND. HD.
37	A/R	A/R	A/R	A/R	SCREW, No. 8-32 x .375 LG. BND. HD.
38	A/R	A/R	A/R	A/R	LOCKWASHER, No. 10 EXTERNAL TOOTH
39	A/R	A/R	A/R	A/R	SCREW, No. 10-32 x .75 LG. BND. HD.
40	A/R	A/R	A/R	A/R	LOCKWASHER, No. 10 EXTERNAL TOOTH
41	A/R	A/R	A/R	A/R	SET SCREW, 6-32 x .75 LG. ALLEN HEAD
42	0	1	0	1	BREATHER, GROUP B, KILLARK
43	0	1	0	1	KNOB
44	5	5	5	5	PIN
45	REF	REF	REF	REF	ROUTE SHEET

DO NOT SCALE DIMS
 UNLESS INDICATED OTHERWISE
 DIMENSIONS ARE IN INCHES UNLESS OTHERWISE SPECIFIED
 ANGLES ARE IN DEGREES UNLESS OTHERWISE SPECIFIED
 FINISHES: LINEAR .XXX ± .010
 RADIUS .XXX ± .010
 HOLE .XXX ± .010

DATE: 02/27/99
 DWT: John Reyes
 APPR: Tim Malynya
 DES: Steve S
 SO: Steve S
 REF: D70680-5

SCALE: 1:2
 SHEET: 1 OF 1
 REV: 3

AS LISTED DIM. NO. D-70682

TEL. FAX. E-MAIL

TITLE: FINAL ASSEMBLY
 OXYGEN MONITOR
 MODEL 3350

Teledyne Analytical Instruments
 A business unit of Teledyne Electronic Technologies
 4000 N. CENTRAL EXPRESSWAY, SUITE 200
 CHICAGO, ILLINOIS 60630