

PEM 9002

Portable Emissions Monitor

(US - Version, V1.0)



TELEDYNE

ANALYTICAL INSTRUMENTS



**16830 Chestnut Street City of Industry,
California 91748, USA**

TEL: 626-934-1500

TOLL FREE: 888-789-8168

FAX: 626-934-1651

www.teledyne-ai.com



WARRANTY SUMMARY

Teledyne warrants that the products it manufactures will be free from defects in materials and workmanship for a period of one year from the date of delivery from factory.

If a product proves defective within the respective period, Teledyne will provide repair or replacement as described in the complete warranty statement.

To arrange for service or obtain a copy of the complete warranty statement, please contact your nearest Teledyne distributor.

EXCEPT AS PROVIDED IN THIS SUMMARY OR THE APPLICABLE WARRANTY STATEMENT, TELEDYNE MAKES NO WARRANTY OF ANY KIND, EXPRESS OR IMPLIED, INCLUDING WITHOUT LIMITATION THE IMPLIED WARRANTIES OR MERCHANTABILITY AND FITNESS FOR A PARTICULAR PURPOSE. IN NO EVENT SHALL TELEDYNE BE LIABLE FOR INDIRECT, SPECIAL OR CONSEQUENTIAL DAMAGES.

Table of Contents

	Page		Page
1	Product Description.....	2	
2	Physical Data.....	5	
2.1	Calculation Formulae	6	
3	Technical Data	7	
4	Front Panel Overview	10	
5	Keypad Functions	11	
6	User Guide	12	
6.1	Program Start Menu	12	
6.2	Calibration Menu	13	
6.3	Fuel Selection	14	
6.4	Additional Functions/Meas. Program....	15	
6.5	Draft Measurement	16	
6.6	Menu Lines.....	17	
6.6.1	Menu Line 1.....	18	
6.6.1.1	Menu - Info Box.....	19	
6.6.1.2	Menu - Time and Date.....	20	
6.6.2	Menu Line 2.....	21	
6.6.2.1	Menu - Graphic.....	21	
6.6.2.2	Menu - Core Of Waste Gas Flow	22	
6.6.2.3	Menu - CO Purge System (manual).....	22	
6.6.3	Menu Line 3	23	
6.6.3.1	Menu - Units	23	
6.6.3.2	Menu - O2-Ref.	23	
6.6.3.3	Menu - Add. Data	24	
6.6.4	Menu Line 4	25	
6.6.4.1	Memory Functions.....	25	
6.6.4.2	Menu - Create memory blocks	29	
6.6.4.3	Menu - Delete memory data	32	
6.6.4.4	Printing the Measured Values	34	
6.7	Configuration Menu	35	
6.8	Entering the Company Address	37	
7	System Maintenance	38	
8	RS 232 Interface	39	
9	Battery / Line Power Operation.....	39	
10	Loading Paper	42	
11	Waste Gas Cleaning System	43	
11.1	Filters And Other Cleaner Parts.....	44	

1. Product Description

The Gas Analysis Computer is a multiple -function analyzer with integrated calculating functions. Measurements are in accordance with the general regulations set forth by the BIMSchV (German Regulations concerning the protection against harmful effects on the environment) at all kinds of combustion plants within the framework of the monitoring of exhaust systems.

a) Measurement and calculation parameters for monitoring exhaust systems and for determining the efficiency of combustion plants:

Measured Values:	T.Gas	Waste or flue gas temperature	°F or °C
	T.Room	Air or ambient temperature	°F or °C
	O2	Oxygen content	% Volume
	CO	Carbon monoxide	ppm - mg/m ³ - mg/kWh
	NO	Nitrogen monoxide (Option)	ppm - mg/m ³ - mg/kWh
	SO2	Sulphur dioxide (Option)	ppm - mg/m ³ - mg/kWh
	Draft	Draft or Pressure	inches of H ₂ O (iWC)
Calculated Values:	CO2	Carbon dioxide	% Volume
	CO 0%	Carbon monoxide, undiluted	ppm
	Effi.	Combustion efficiency	%
	Ex.air	Excess air value	
	Losses	Waste gas losses	%
	NOx	Nitrogen oxides (optional)	ppm - mg/m ³ - mg/kWh
	T.Diff	Differential temperature (TG-TA)	°F or °C

b) Measuring Procedure

- Temperature Measurment.: K-type thermocouple (NiCr-Ni) for waste or flue gas temperature
K-type thermocouple (NiCr-Ni) for air or ambient temperature.
- O₂-Measurement : Electrochemical measuring cell.
- CO-Measurement : Electrochemical measuring cell.
- Draft Measurement : Piezo-resistive principle with internal temperature compensation.
- Measuring Duration: Short-term memory measurements of max. 60 minutes are possible, followed by a new calibration phase with ambient air.
- Waste Gas Measurement : Via an external water separator and filter, the waste gas is fed to the sensors by means of a gas feed pump. The pump capacity during the feeding phase is approx. 0.8 l/min.
- Sensor Calibration: 60 seconds after switching on the instrument.
- CO Concentration: CO sensor with H₂ compensation, measuring range 0 - 4.000 ppm. Cutoff threshold at 4.000 ppm for sensor protection via separate flush pump.
The remaining measuring values are not affected. The instrument is switched on again at a value of 1.600 ppm.
- Waste Gas Sampling: By means of a waste gas sampling probe with retainer cone.

c) Instrument Description

Electrical Supply:	NiCad battery 6V/4.0 Ah, external charger.
Display:	With backlight; alphanumeric and graphic display. 4 lines of 16 characters each, plus menu line.
Computer Interface:	RS 232.
Printer Interface:	Pin Printer (Normal Paper).
Printer:	External infrared thermo-paper printer.
Memory:	100 memory blocks
Adm. Operating Temp.:	+ 40 °F to + 104 °F (+ 5°C to + 40°C).
Adm. Storage Temp.:	-22 °F to + 140 °F (- 30°C to + 50 °C).
Mech. Dimensions:	10.6" x 9.6" x 6.9" (270 x 245 x 175 mm).
Weight:	8.0 lbs (3,8 kg).
Standard Version:	Instrument, battery charger, combined flue gas temperature probe / watertrap and hose assembly with measuring cone, ambient air temperature sensor, carrying case and manual.

2. Physical Data

Measuring ranges: (General Specifications)

CO	0 ... 4.000 ppm
CO-0%	0 ... 9.999 ppm
O2	0 ... 20,9 % Volume
T.Gas	+ 32 °F to + 1.850 °F (0 °C ... + 1.000 °C)
T.Room	-5 °F to + 212 °F (-20 °C ... +100 °C)
Draft/Pressure	± 60 inches of H2O (± 150.0 hPa)
CO2	0,0 ... CO2 max % Volume
Losses	0 ... 100%
Efficiency	100 ... 0%
Excess air	1 ... 99.999.

Optional:

NOx, NO	0 ... 2.000 ppm
SO2, NO	0 ... 2.000 ppm
CO High	0 ... 1.0 % Volume (10.000 ppm)

2.1 Calculation Formulae

Calculation of the CO₂ value:
$$\text{CO}_2 = \text{CO}_{2\text{max}} * \left(1 - \frac{\text{O}_2}{20.9} \right) \text{ in \% Volume}$$

CO₂max: Max. CO₂-value (fuel-specific) in % Volume.
 O₂: Measured oxygen content in % Volume.
 21: Oxygen content of the air in % Volume.

Calculation of the waste gas loss:
$$qA = (\text{T.Gas} - \text{T.Air}) * \left(\frac{A_2}{21 - \text{O}_2} + B \right) \text{ in \%}$$

T.Gas: Waste / flue gas temperature in °F or °C.
 T.Room: Combustion / ambient temperature in °F or °C.
 A₂, B: Fuel-specific factors.

Calculation of the excess air value (Lambda):
$$\text{Lambda} = \frac{\text{CO}_{2\text{max}}}{\text{CO}_2} = \frac{20.9}{20.9 - \text{O}_2}$$

Calculation of the combustion efficiency value (Eta):
$$\text{Eta} = 100 - qA \text{ in \%}$$

Calculation of CO 0% (undiluted):
$$\text{CO0\%} = \text{CO} * \text{Lambda} \text{ in ppm}$$

3. Technical Data

Waste or Flue Gas Temperature Measurement

Sensor: K-type thermocouple
Range: +32 °F to 1.850 °F (0 to + 1.000 °C)
Resolution: 0.1 °F or °C
Accuracy: ±2°F / ±1°C (0 to + 400 °C)
±0.5 % of reading (up to 1.000 °C)

Combustion Air or Ambient Temperature Measurement

Sensor: K-type thermocouple
Range: -5 °F to + 212 °F (-20 to + 100 °C)
Resolution: 0.1 °F or °C
Accuracy: ±2°F / ±1°C (0 to + 100 °C)
±6°F / ±3°C (-20.0 to 0.0 °C)

Draft or Pressure Measurement

Sensor: Piezoresistive pressure sensor
Range: ± 60 in. H₂O or ± 150 hPa
Resolution: 0.01 in. H₂O or hPa
Accuracy: ±0.08 in.H₂O or ±0.02 hPa (up to ±8.0 in. H₂O or ± 2.00 hPa)
± 1 % of reading (up to ±80.0 in. H₂O or ± 20.0 hPa)
± 3 % of reading (above ±80.0 in. H₂O or ± 20.0 hPa)

Oxygen (O2) Measurement

Range: 0 to 20.9 % Volume
Accuracy: ± 0.2 % Volume
Resolution: 0.1 % Volume
Sensor: Electro-chemical cell
Response time (T97): < 70 sec

Carbon dioxide (CO2) Calculation

Calculated from O2 measurement

Range: 0 to CO2 max.
Accuracy: ± 0.2 % Volume
Resolution: 0.1 % Volume
Response time (T97): < 70 sec

Carbon monoxide (CO) Measurement (with H2 compensation)

Range: 0 to 4.000 ppm
Accuracy: ± 5 ppm (up to 150 ppm)
 ± 5 % of reading (up to 4.000 ppm)
Resolution: 1 ppm
Sensor: Electro-chemical cell
Response time (T90): < 60 sec

Options

Nitrogen monoxide (NO) Measurement

Range:	0 to 2.000 ppm
Accuracy:	± 5 ppm (up to 150 ppm) ± 5 % of reading (up to 2.000 ppm)
Resolution:	1 ppm
Sensor:	Electro-chemical cell
Response time (T90):	< 60 sec

CO Measurement (without H2 compensation)

Range:	0 ... 1.0 % Volume (10.000 ppm)
Resolution:	0.01 % Volume
Sensor:	Electro-chemical cell
Response time (T90):	< 60 sec

Sulphur dioxide (SO2) Measurement

Range:	0 to 2.000 ppm
Accuracy:	± 5 ppm (up to 150 ppm) ± 5 % of reading (up to 2.000 ppm)
Resolution:	1 ppm
Sensor:	Electro-chemical cell
Response time (T90):	< 60 sec

4 Front Panel Overview

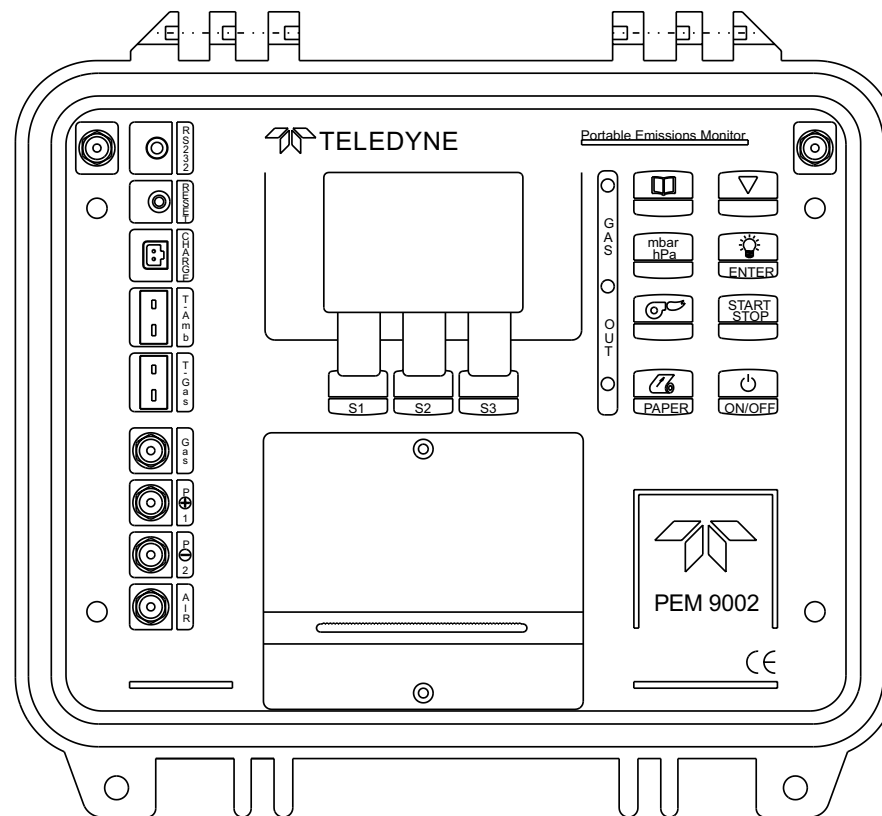

5 Keypad Functions

 On / Off

 to  Soft Keys

 Start Measurements
Gas Feed Pump On / Off

 Scroll Measurements

 Fuel Selection

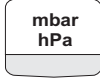
 Start Draft Measurement

 Scroll Key

 Backlight On / Off
Confirm in Memory Mode

6 User Guide

6.1 Program Start Menu

Switch on the instrument



Start Measurements



Calls up the memory program



Call up the Configuration Menu



Measure <START>
Memory <S1>
Config. <S2>
Batt: ██████████

S1	S2	S3
----	----	----

Note: The battery status is determined by how many battery symbols that are dark.

7 dark symbols = 70 % of battery power capacity

6.2 Calibration Menu

Note: Do not place probe - Leave in ambient air until the unit is finished with the calibration phase.

Note: Any errors that occur during calibration are displayed on the information line.

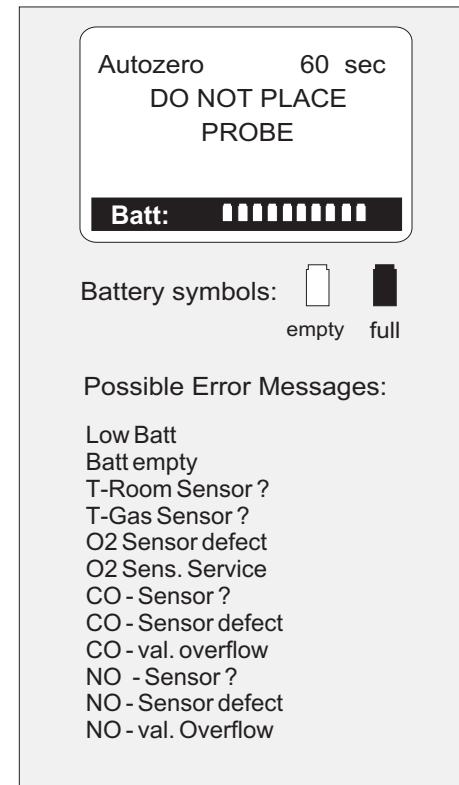

6.3 Fuel Selection

Select fuel menu



Scroll through list to select fuel be used



List of possible fuels:

No. 2 Fuel Oil	Northsea gas
Natural Gas	No. 6 Fuel Oil
Propane	No. 4 Fuel Oil
Butane	

Confirm selected fuel



Within the measuring program, all measured values can be displayed by scrolling down (the values are viewed 4 at a time)





FUEL SELECTION
No. 2 Oil
Natural Gas
Propane

S1	S2	S3
----	----	----

O2 20.9 %
CO 0 ppm
CO2 0.0 %
Looses ---- %

Hold	Zoom▼	Info
------	-------	------

6.4 Additional Functions of the Measuring Program

Fuel Selection	
Gas Feed Pump	
Display Illumination	

Change Fuel Selection

Gas Pump On / Off

Backlight On / Off

6.5 Draft Measurement

Start draft measurement
from the measuring program:



Attention:
No pressure values Exceeding ± 60 inches of H₂O
(± 150 hPa mbar)!

Note:
For draft Measurement, connect air tube to the positive (+)
connector only.

Hold Hold measured values



Return Terminate draft measurement



Before pressing the mbar/hPa key,
pull the air tube off the instrument!
The draft sensor is calibrated
(0.00 InW or hPa).

Draft Measur.		
T.Gas	415.4 °F	
Draft	0.00 InW	
Hold		Return

Carefully replace the air tube.
Wait until the measured value has
stabilized.

Record the measured draft value.

This value is stored with the current
measuring values.
The measuring mode is continued.

6.6 Menu Lines

Display next menu line



The menu line makes it possible to operate the instrument in a fast and easy way. Pressing the appropriate soft key (S1 to S3) accesses submenu directly and/or allows direct execution of a function.

A large rectangular area representing the instrument's main menu display. It contains several rows of data and soft key options.

CO 0%	0 ppm	
Ex.air	-----	
T.Gas	71.3 °F	
T.Room	71.4 °F	
Hold	Zoom	Info

Hold	Zoom	Info
------	------	------

Graphic	max.Draft	CO-Protect
---------	-----------	------------

Unit	O2-ref.	Add.Data
------	---------	----------

Hold	Memory	Print
------	--------	-------

6.6.1 Menu Line 1

Hold Intermediate storage of measured values 

Zoom Enlarged display of measured values 

Print
Or
Info Opens the Information Box 

Note: The information Box displays the current status of battery, the selected fuel type (including CO2 max value) and the O2 reference value for converting units.

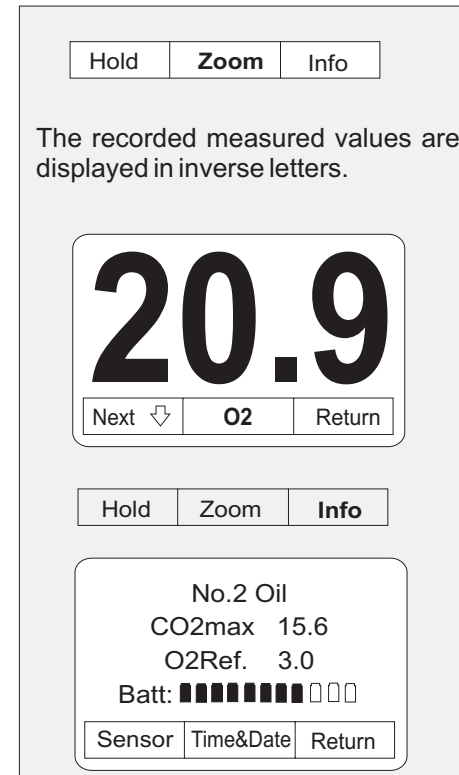

6.6.1.1 Menu: Information Box

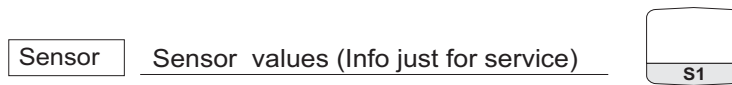

Momentary Sensor failure or degrading can be solved by longer flush periods in ambient air or / and by exchanging the filter elements.

Note:

If the failure or degrading keeps occuring and cannot be fixed, please contact the supplier!

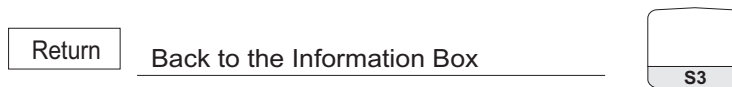

The information box contains a table with three columns: "Sensor", "Time&Date", and "Return". Below the table is a list of sensor readings: O2 Sensor (75%), CO Sensor (0%), H2 Sensor (0%), and NO Sensor (0%). At the bottom of the list is a "Return" button. Below the list is the "Sensor Status" section, which includes: "O2 reading: > 50 %", "O2 Sensor OK", "CO & H2 reading: 0 to + 1 %", "CO Sensor OK", "NO reading: 0 to +1 %", and "NO Sensor OK".

Sensor	Time&Date	Return
O2 Sensor		75 %
CO Sensor		0 %
H2 Sensor		0 %
NO Sensor		0 %
		Return







Sensor Status:
O2 reading: > 50 %
O2 Sensor OK

CO & H2 reading: 0 to + 1 %
CO Sensor OK

NO reading: 0 to +1 %
NO Sensor OK

6.6.1.2 Menu: Time and Date

From Informations Menu

Time&Date	Call up time and date	
Edit.time	Set current time	
Edit.date	Set current date	
	Change numerical value	
	Advance to the next digit position	
Return	Terminate editing function	

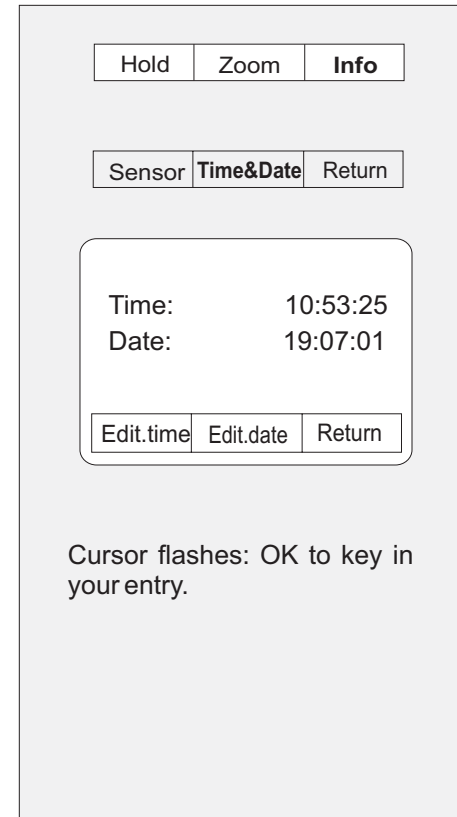

The screenshot shows a menu interface with the following elements:



- Top navigation bar: Hold | Zoom | Info
- Second bar: Sensor | **Time&Date** | Return
- Central display area:
 - Time: 10:53:25
 - Date: 19:07:01
- Bottom bar: Edit.time | Edit.date | Return

Cursor flashes: OK to key in your entry.

6.6.2 Menu Line 2

From the measuring program:

6.6.2.1 Menu: Graphic

Graphic	Call up the Graphics Menu	
Hold	Intermediate storage of the graphics	
Return	Terminate graphics menu	

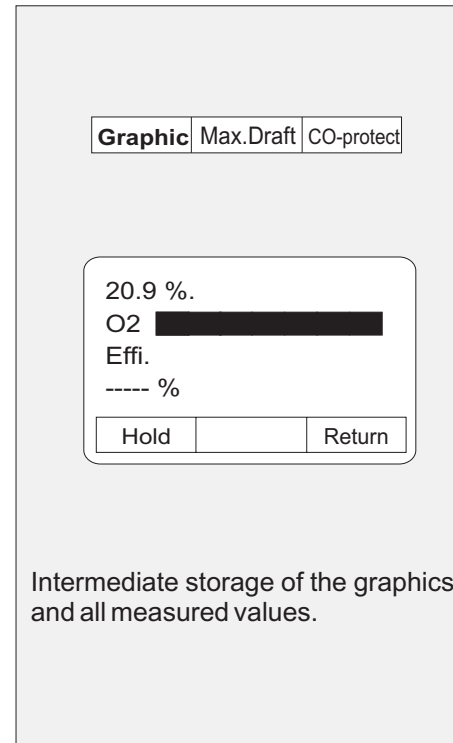

Graphic Max.Draft CO-protect

20.9 %.
O2 ██████████
Effi.
---- %

Hold Return

Intermediate storage of the graphics
and all measured values.

6.6.2.2 Menu: Core of waste gas flow (Max. Draft)

From the measuring program:

Enter Max. Draft Menu



The menu: 'Max. Draft' provides a graphic display of such tendencies as rising or falling temperatures, which are indicated by oscillations of the bar graph. As soon as the temperature has stabilized the bar graph appears in the center of the display.

Note: If necessary, intermediate storage of measured values is possible as follows:

Intermediate storage of measured values



Terminate Max. Draft menu



6.6.2.3 Menu: CO Purge System (manual)

CO Flush pumps On / Off



Max. Draught det.

+	■	-
T.Gas	125.5 °F	
O2	20.9 %	

Hold		Return
------	--	--------

All measured value will be stored in the intermediate storage.

When the over-range value of 4.000 ppm has been reached the CO flush pump is switched on **automatically**.

6.6.3 Menu Line 3

From the measuring program:

6.6.3.1 Menu: Units

Unit	Call up the 'Units' Menu	S1
------	--------------------------	----

S1	Change units to mg/m ³	S1
----	-----------------------------------	----

S2	Change units to ° C	S2
----	---------------------	----

6.6.3.2 Menu: O2 - Reference

From the measuring program:

S2	Confirm O2 reference and terminate	S2
----	------------------------------------	----

Unit	O2-ref.	Add.Data
------	---------	----------

Dimensions

in mg/m³ < S1 >
in ° C < S2 >
Break < S3 >

S1	S2	S3
----	----	----







Unit	O2-ref.	Add.Data
------	----------------	----------

O2 - Ref. 3.0
Enter

ABCabc0123/-+.	Return
----------------	--------

6.6.3.3 Menu: Additional Data (add. Data)

From the measuring program:

Add.Data	<u>Calls up menu for entering additional data</u>	
Select	<u>Select Line</u>	
Edit	<u>Change Value</u>	
	<u>Change numerical value</u>	
	<u>Advance to the next digit position</u>	
Return	<u>Terminate editing function</u>	

Unit	O2-ref.	Add.Data
------	---------	-----------------

smoke-no.	
Oilderivate	
T.boiler: 0 °F	

Edit	Select	Return
------	--------	--------

The selected option is shown in a frame.

A flashing cursor appears at the first entry position.

Select between **Yes** and **No** for oil derivatives.

6.6.4 Menu Line 4

From the Measuring Program:

6.6.4.1 Memory Functions

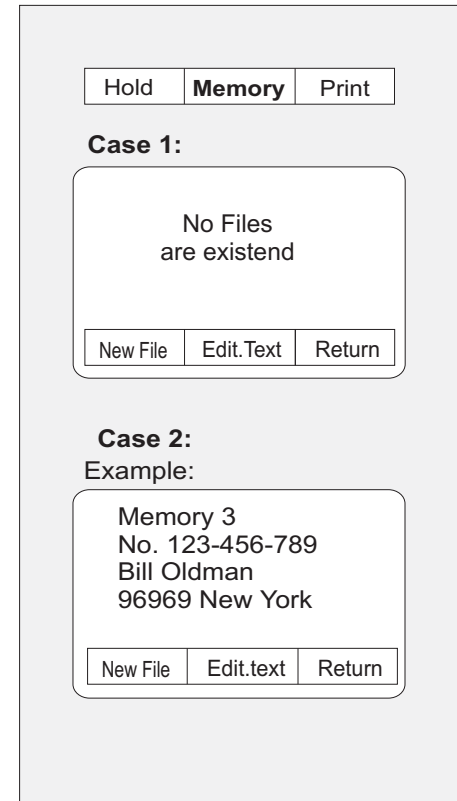
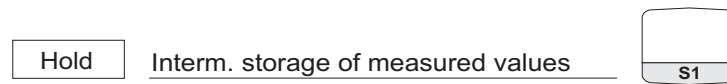



Case 1: No memory blocks created.

NewFile Create new memory block 

Creates a memory block with additional data (e.g. type of combustion plant, customer address etc.) see Section 6.6.4.2, page 29.

Return Confirm memory block generation. 

Calls up the next memory menu 

Save Stores measured values 

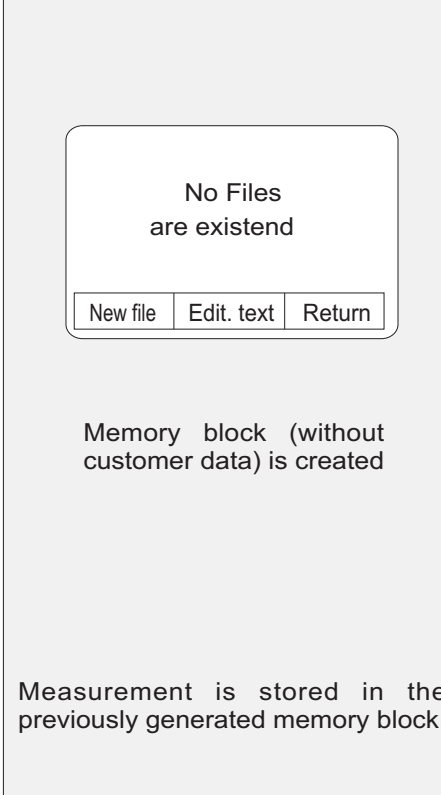

No Files
are existend

New file Edit. text Return

Memory block (without
customer data) is created

Measurement is stored in the
previously generated memory block.

Case 2: Memory blocks already exist.

(Please refer to Section 6.6.4.2 "Create Memory Blocks")

Scrolls existing memory blocks



Save

Stores measured values in the selected block









Memory 1
No.

Display | Save | Return

Intermediately stored measured values are now stored in the selected memory block!

Other Memory Functions

Note: If memory blocks exist, stored data can be accessed as follows:

		
	Scrolls existing memory blocks	
<input type="button" value="Display"/>	Views selected memory blocks	
		
	Scrolls measuring data in the memory	
<input type="button" value="Grafic"/>	Graphics display of measured values	
<input type="button" value="Print"/>	Prints the stored measurement	
<input type="button" value="Return"/>	Terminates the View function	

Memory 3
No. 123-456-789
Bill Oldman
9696 New York

Time: 14:23:07
Date: 27.07.01
No. 123-456-789
Natural Gas

6.6.4.2 Menu: Create Memory Blocks

Generation of memory blocks and entry of customer data

Calls up other lines of the memory menu.



New File

Creates new memory block.



Edit

Enter customer number



0123 /-+.

Selects the character set



Selects characters



Advances to next digit position



Return

Terminates entry



New File	Edit.text	Return
----------	-----------	--------

Nr:







Edit	Select	Return
------	--------	--------

Toggles between figures and special characters

Available characters for (customer) code:

Figures: 0 to 9
Special characters: - + . , : * > < /

You can enter up to 13 consecutive characters into the (customer) code line.

Select	Selects the next entry line	
Edit	Switches on the entry mode	
ABC abc	Character set: Capitalization/Small Initial Letters	
0123 /-+.	Character set: Figures/Special Characters	
Selects Characters		
Advances to the next digit position		
Return	Terminates entry.	

No.:

Edit
Select
Return

Toggles between capitalization and small letters.

Toggles between figures and special characters.

Available selection of characters:

Letters: a to z, ä, ö, ü, ß

Letters: A to Z, Ä, Ö, Ü

Figures: 0 to 9

Special characters: - + . , : * > < /

Up to 16 characters can be entered consecutively.

Select Selects the next entry line. 

Up to four lines of customer data can be entered.

Return Returns to the measuring menu. 

Display next menu line 

The memory block is saved for later measurements or until it is deleted again.





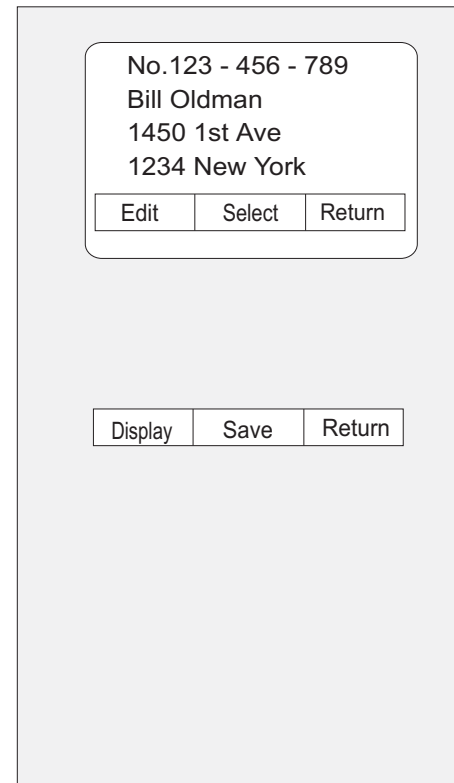

Stored values can be viewed by means of menu point 'Display

New measured values can be stored in the memory block by means of menu point 'Save'.



The screenshot shows a device screen with a light gray background. At the top, there is a rounded rectangular box containing the text: "No.123 - 456 - 789", "Bill Oldman", "1450 1st Ave", and "1234 New York". Below this text is a horizontal menu bar with three buttons: "Edit", "Select", and "Return". Further down the screen, there is another horizontal menu bar with three buttons: "Display", "Save", and "Return".

6.6.4.3 Menu: Delete Memory Data

	
<u>Calls up other memory menus</u>	
	
<u>Selects the block to be deleted</u>	
<u>Del.measur.</u> <u>Deletes the measurement</u>	
<u>Deletes block incl. additional data</u>	
<u>Deletes measurement only</u>	
<u>Abort</u>	

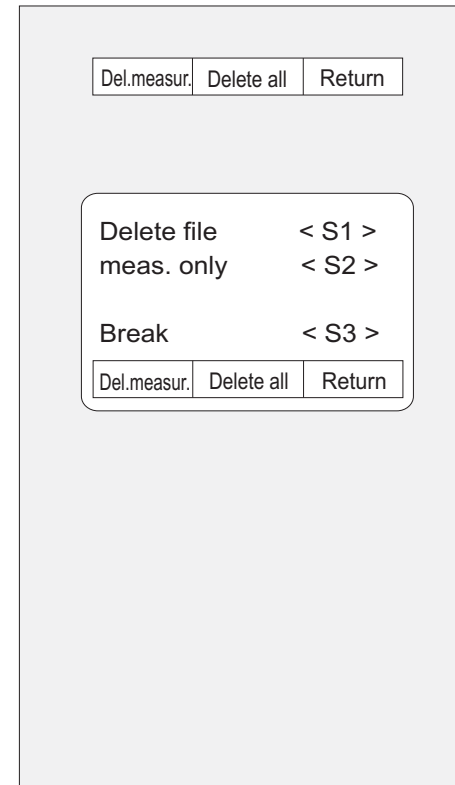

Delete all Clears all memories 

Deletes all 

Attention: All memories including additional data will be deleted!

Deletes measurements only 

Abort 

Return Terminates memory function 

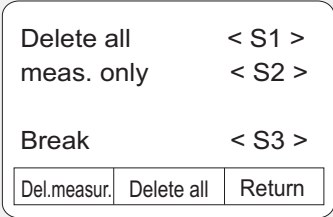

Returns to measuring menu.

6.6.4.4 Printing the Measured Values

Direct printout from the measurement:

Printout of current measuring values 

Printout of intermediately stored values:

Intermediate storage of measured values 

Printout of measured values 

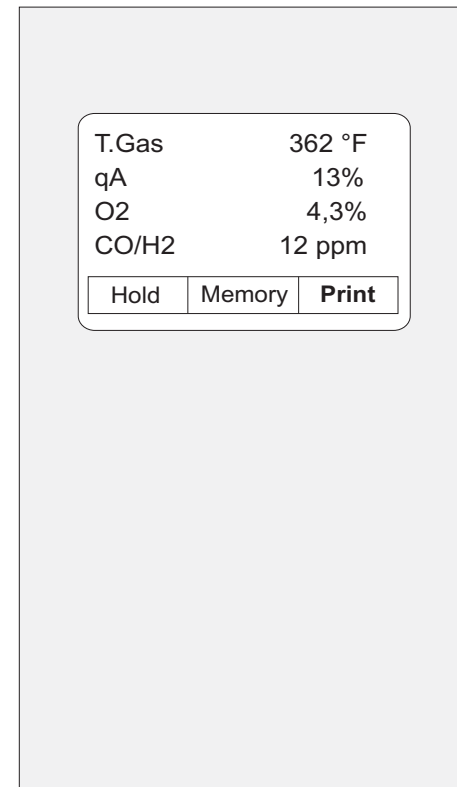

T.Gas	362 °F	
qA	13%	
O2	4,3%	
CO/H2	12 ppm	
<input type="button" value="Hold"/>	<input type="button" value="Memory"/>	<input type="button" value="Print"/>

6.7 Configuration Menu

From the Program Start Menu:

Call up the Configuration Menu



Changing the Configuration Data:

Sound Switches the acoustic signal On / Off



Illumination Sets the time interval for the display back light



Stores the configuration data



Aborts the Configuration Menu



Measure	<START>
Memory	<S1>
Config.	<S2>
Batt:	

S1	S2	S3
----	----	----

Sound	Yes
Illum.off	0
Save	< E >
Continue	<Start>

Auto-off	Illumination	Reset
----------	--------------	-------

Adjustable display illumination
from 0 - 90 seconds
in increments of 5 seconds.

From the Configuration Menu

Reset _____ Resets all instrument parameters



Attention: Confirming Reset with ENTER cancels all instrument settings. All memory blocks are deleted.

_____ Confirm Reset



_____ Aborts the Reset routine



Auto-off	Illumination	Reset
----------	--------------	--------------

Delete Memory
prog. keys reset
press <E>

Break S3

S1	S2	S3
----	----	----

Returns to the Measuring Mode.

6.8 Entering the Company Address

From the Program Start Menu:

Call up the Configuration Menu



From the Configuration Menu:

Call up Address Entry



Switch on the Entry Mode



Entry of letters, figures and special characters
as in the memory mode (Section 6.6.4.2).

Advance to the next line.



Terminate Address Entry



Sound	Yes	
Illum. off	0	
Save	< E >	
Continue	<Start>	
Sound	Illumination	Reset

Edit. Printerheader		
COMPANY		
Address		
Phone-No.		
Edit	Select	Return

The entered or corrected company address is now saved and will always appear on the printout of measuring data.

7. System Maintenance

Waste Gas Cleaning System: See drawing on page 42.

Attention: **Empty the condensate reservoir completely after each measuring operation. Water residues within the measuring instrument will destroy the pumps and sensors!**
Damage of the filter and / or improperly fitted filter will greatly decrease or eliminate the filter function and will eventually destroy pumps and sensors.

Check the microfilter for contaminations and replace as necessary.

If the pump capacity is reduced, exchange the diaphragm filter.

Make sure that threaded parts are straight when placed on and tighten them moderately. Ensure sufficient sealing by means of O-rings.

**Plug-type elements
and flanges:**

Remove any gas residues. Grease with Vaseline.

Storage:

Store in a cool and dry environment at a temperature of approx. 60 °F (20 °C).

Damages: **Guarantee and warranty obligations do not apply to damages caused by improper handling, negligence and grave external influences.**

8. RS - 232 Interface

Provides connections for special Service and Data Communications.

9. Battery / Line Voltage Operation

Battery operation: Maximum 36 hours of continuous measuring.

Battery charger: External charger 110 V~/ 60 Hz.
Intelligent monitoring by means of instrument-integrated microcontroller

To maintain the service life and performance of the NiCad battery, please observe the instructions under 'Information on charging the battery'.

Status display of the storage battery:

Shown on the bottom line of the display during the calibration phase.
During the measurement, the status of the battery can be read from The 'Info' Menu.

Information on Charging the Battery

PEM9002 is equipped with an NiCad storage battery. The service life and capacity of the battery are considerably affected by the way the instrument is charged and used. In order to make the handling safer, the instrument has a load management unit.

If an NiCad battery is, for example, always charged from 80% to 100% and never run down to the final discharge voltage, it will lose some of its capacity. This is called the 'memory effect' , i.e. the battery remembers to what extent it is run down.

A part of this memory effect is suppressed in the PEM9002 in that the battery cannot be recharged until it has dropped below 60%.

Constant overcharging, too, has adverse effects on the NiCad battery. In order to prevent this, the charged capacity, the voltage and the temperature of the battery are monitored in the PEM9002. When predefined limits are exceeded, the charging process is interrupted. After the appropriate parameters have been neutralized the charging process is automatically restarted again.

The service life of the NiCad battery can be significantly reduced when the instrument is operated at temperatures below 40 °F (5°C).

The graphic charge-level indicator of the PEM9002 (10 battery symbols), which appears in the one-line status display during the calibration phase, helps the user estimate correctly the capacity of the battery. The instrument continuously measures the incoming and outgoing current during operation and charging. Under normal operating conditions, the instrument should be operated until the battery is completely run down. When this advice is followed, the actual capacity of the NiCad battery will definitely be shown on the display.

Storing the instrument is only recommended if the NiCad battery is fully charged. If the instrument has to be stored for a prolonged time (approx. 2 weeks or longer) it is recommended to leave the instrument connected to the charger. The same applies to low-level discharge of the battery: leave the instrument connected to the charger for a longer period (up to 12 hours).

If the instrument is operated at temperatures exceeding the admissible temperature range, if the NiCad battery is older, or if incomplete charging cycles (charging/discharging) are performed, it is possible that the display no longer corresponds to the current status of the battery.

In this case the display is corrected as follows: discharge the battery by switching on until the instrument switches off automatically. After that, connect the instrument to the associated charger and wait until the end of the charging period (max. 4 hours). When the charging process is completed, the PEM9002 switches off automatically.

Used or Dead Battery

For replacement of a Used or Dead battery, the analyzer has to sent back to the supplier / manufacturer.

10. Loading Paper

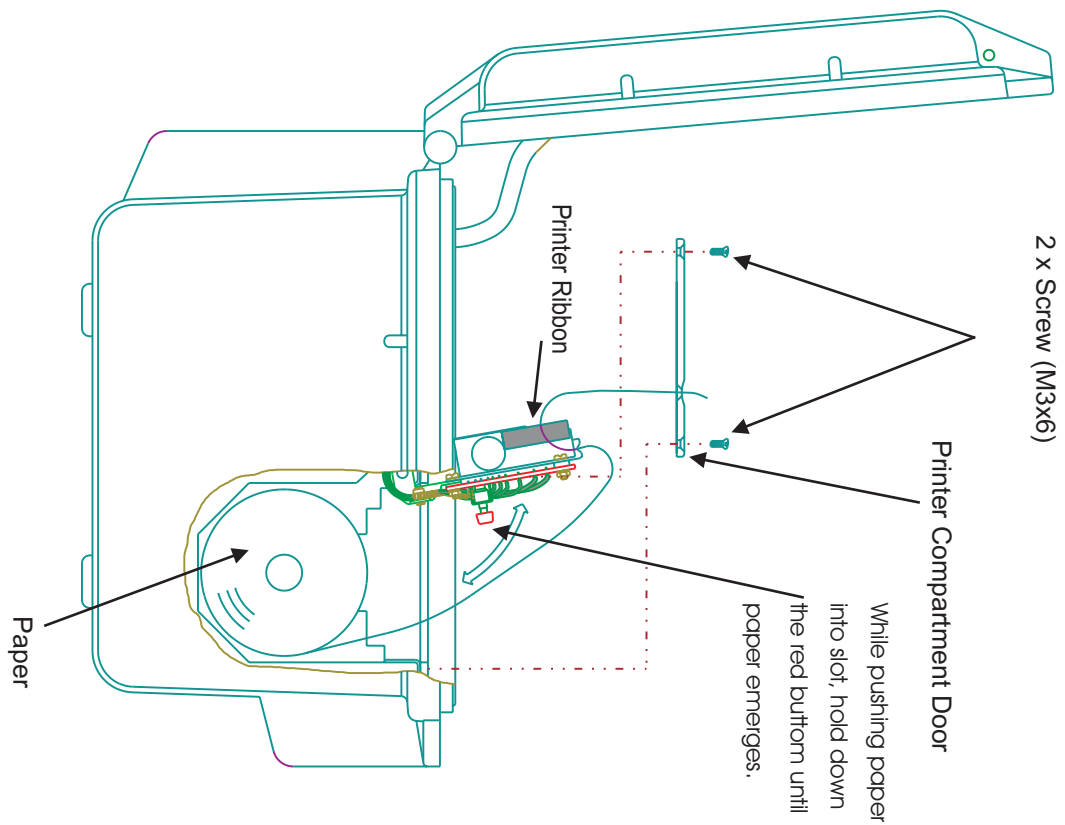

11. Waste Gas Cleaning System

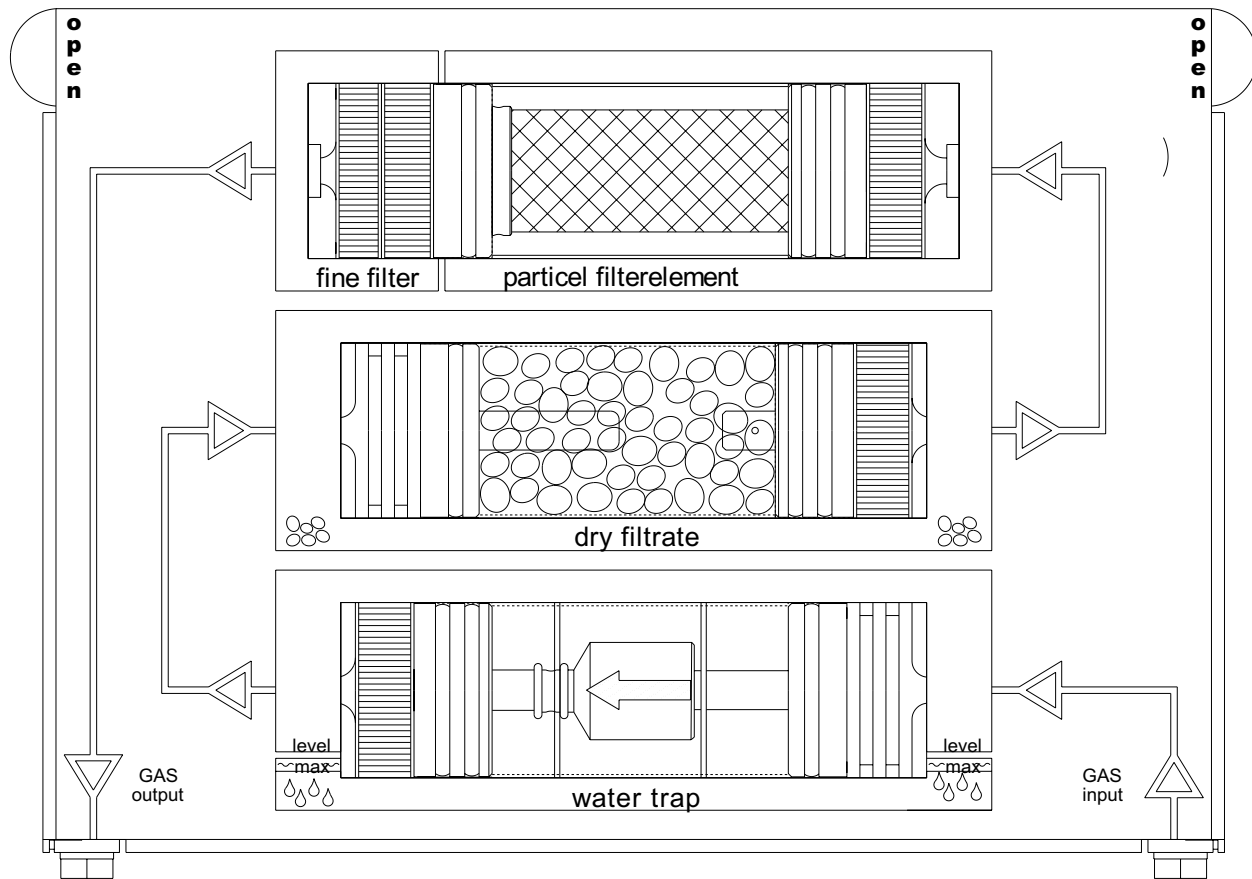

11.1 PEM 9002 - Filters and other cleaner parts

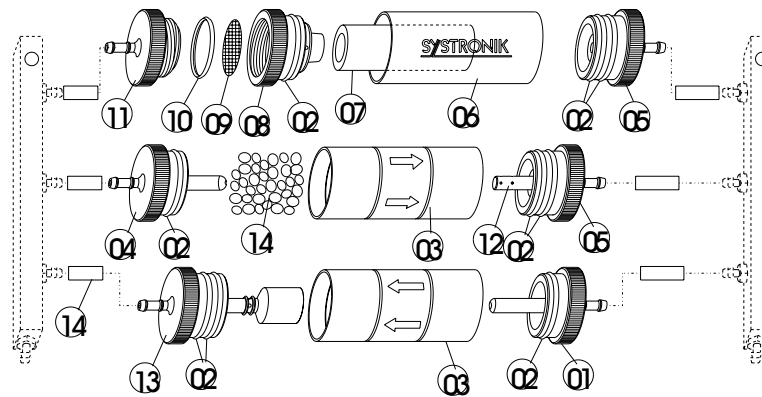

Replacement Parts(Part No.): 20594 (01) / 20370 (02) / 20596 (03) / 22049 (04) / 21954 (05) / 21779 (06) / 20919 (07) / 20592 (08) / 20921 (09) / 20365 (10) / 20591 (11) / 21955 (12) / 22017 (13) / 21427 (14)

Maintenance:

- Empty the condensate reservoir after each measuring operation.
- Check the microfilter for contaminations and change as necessary.
- If the pump capacity decreases, change the hydrophob filter.

Attention! Damaging the filter or inserting it incorrectly will lead to invalid results!
Grease all tight or stiff parts with vaseline.