

Use and Disclosure of Data
Information contained herein is classified as EAR99 under the U.S.
Export Administration Regulations. Export, reexport or diversion
contrary to U.S. law is prohibited.



OPERATING INSTRUCTIONS FOR

MODEL 3000RS-TXL

Trace Oxygen Analyzer



P/N M95455TXL
ECO 24-0030
02/10/25

	DANGER	
<p>Toxic gases and or flammable liquids may be present in this monitoring system.</p> <p>Personal protective equipment may be required when servicing this instrument.</p> <p>Hazardous voltages exist on certain components internally which may persist for a time even after the power is turned off and disconnected.</p> <p>Only authorized personnel should conduct maintenance and/or servicing. Before conducting any maintenance or servicing, consult with authorized supervisor/manager.</p>		

Copyright © 2018 Teledyne Analytical Instruments

All Rights Reserved. No part of this manual may be reproduced, transmitted, transcribed, stored in a retrieval system, or translated into any other language or computer language in whole or in part, in any form or by any means, whether it be electronic, mechanical, magnetic, optical, manual, or otherwise, without the prior written consent of Teledyne Analytical Instruments, 16830 Chestnut Street, City of Industry, CA 91748.

Warranty

This equipment is sold subject to the mutual agreement that it is warranted by us free from defects of material and of construction, and that our liability shall be limited to replacing or repairing at our factory (without charge, except for transportation), or at customer plant at our option, any material or construction in which defects become apparent within one year from the date of shipment, except in cases where quotations or acknowledgements provide for a shorter period. Components manufactured by others bear the warranty of their manufacturer. This warranty does not cover defects caused by wear, accident, misuse, neglect or repairs other than those performed by Teledyne or an authorized service center. We assume no liability for direct or indirect damages of any kind and the purchaser by the acceptance of the equipment will assume all liability for any damage which may result from its use or misuse.

We reserve the right to employ any suitable material in the manufacture of our apparatus, and to make any alterations in the dimensions, shape or weight of any parts, in so far as such alterations do not adversely affect our warranty.

Important Notice

This instrument provides measurement readings to its user and serves as a tool by which valuable data can be gathered. The information provided by the instrument may assist the user in eliminating potential hazards caused by his process; however, it is essential that all personnel involved in the use of the instrument or its interface, with the process being measured, be properly trained in the process itself, as well as all instrumentation related to it.

The safety of personnel is ultimately the responsibility of those who control process conditions. While this instrument may be able to provide early warning of imminent danger, it has no control over process conditions, and it can be misused. In particular, any alarm or control systems installed must be tested and understood, both as to how they operate and as to how they can be defeated. Any safeguards required such as locks, labels, or redundancy, must be provided by the user or specifically requested of Teledyne at the time the order is placed.

Therefore, the purchaser must be aware of the hazardous process conditions. The purchaser is responsible for the training of personnel, for providing hazard warning methods and instrumentation per the appropriate standards, and for ensuring that hazard warning devices and instrumentation are maintained and operated properly.

Teledyne Analytical Instruments, the manufacturer of this instrument, cannot accept responsibility for conditions beyond its knowledge and control. No statement expressed or implied by this document or any information disseminated by the manufacturer or its agents, is to be construed as a warranty of adequate safety control under the user's process conditions.

Specific Model Information

The instrument for which this manual was supplied may incorporate one or more options not supplied in the standard instrument. Commonly available options are listed below, with check boxes. Any that are incorporated in the instrument for which this manual is supplied are indicated by a check mark in the box.

Instrument Serial Number: _____

Options Included in the Instrument with the Above Serial Number:

- 3000RS-XL-C:** In addition to all standard features, this model also has separate ports for zero and span gases, and built-in control valves. The internal valves are entirely under the control of the 3000RS electronics to automatically switch between gases in synchronization with the analyzer's operation.
- 19" Rack Mount:** The 19" Relay Rack Mount units are available with up to four 3000RS series analyzers installed in a custom 19" panel and ready to mount in a standard instrument rack.

Sensor Options Available for the Instrument with the Above Serial Number:

- A2CXL**
- B2CXL**
- B2C**
- INSTA-TRACE**_____

Important Notice

Model 3000RS-TXL complies with all of the requirements of the Commonwealth of Europe (CE) for Radio Frequency Interference, Electromagnetic Interference (RFI/EMI), and Low Voltage Directive (LVD).

The following International Symbols are used throughout the Instruction Manual. These symbols are visual indicators of important and immediate warnings and when you must exercise CAUTION while operating the instrument. See also the Safety Information on the next page.



STAND-BY: Instrument is on Stand-by, but circuit is active.



GROUND: Protective Earth



CAUTION: The operator needs to refer to the manual for further information. Failure to do so may compromise the safe operation of the equipment.



CAUTION: Risk of Electrical Shock

Safety Messages

Your safety and the safety of others is very important. We have provided many important safety messages in this manual. Please read these messages carefully.

A safety message alerts you to potential hazards that could hurt you or others. Each safety message is associated with a safety alert symbol. These symbols are found in the manual and inside the instrument. The definition of these symbols is described below:



GENERAL WARNING/CAUTION: Refer to the instructions for details on the specific danger. These cautions warn of specific procedures which if not followed could cause bodily Injury and/or damage the instrument.



CAUTION: HOT SURFACE WARNING: This warning is specific to heated components within the instrument. Failure to heed the warning could result in serious burns to skin and underlying tissue.



WARNING: ELECTRICAL SHOCK HAZARD: Dangerous voltages appear within this instrument. This warning is specific to an electrical hazard existing at or nearby the component or procedure under discussion. Failure to heed this warning could result in injury and/or death from electrocution.



Technician Symbol: All operations marked with this symbol are to be performed by qualified maintenance personnel only.

No
Symbol

NOTE: Additional information and comments regarding a specific component or procedure are highlighted in the form of a note.

CAUTION: THIS PRODUCT SHOULD ONLY BE INSTALLED, COMMISSIONED, AND USED STRICTLY FOR THE PURPOSE AND IN THE MANNER DESCRIBED IN THIS MANUAL.



IF YOU IMPROPERLY INSTALL, COMMISSION, OR USE THIS INSTRUMENT IN ANY MANNER OTHER THAN INSTRUCTED IN THIS MANUAL OR BY OUR TECHNICAL SUPPORT TEAM, UNPREDICTABLE BEHAVIOR COULD RESULT WITH POSSIBLE HAZARDOUS CONSEQUENCES.

SUCH RISKS, WHETHER DURING INSTALLATION AND COMMISSION OR CAUSED BY IMPROPER INSTALLATION/COMMISSIONING/USE, AND THEIR POSSIBLE HAZARDOUS OUTCOMES INCLUDE BUT ARE NOT LIMITED TO:

RISK	HAZARD
Liquid or dust/debris ingress	Electrical shock hazard
Improper or worn power cable	Electrical shock or fire hazard
Excessive pressure from improper gas bottle connections	Explosion and projectile hazard
Sampling combustible gas(es)	Explosion and fire hazard
Improper lift & carry techniques	Personal injury

NOTE THAT THE SAFETY OF A SYSTEM THAT MAY INCORPORATE THIS PRODUCT IS THE END USER'S RESPONSIBILITY.

This manual provides information designed to guide you through the installation, calibration, and operation of your new analyzer. Please read this manual and keep it available.

Occasionally, some instruments are customized for a particular application or features and/or options added per customer requests. Please check the front of this manual for any additional information in the form of an Addendum which discusses specific information, procedures, cautions and warnings that may be peculiar to your instrument.

Manuals do get lost. Additional manuals can be obtained from Teledyne at the address given in the Appendix. Some of our manuals are available in electronic form via the internet. Please visit our website at: www.teledyne-ai.com.



This is a general-purpose instrument designed for use in a nonhazardous area. It is the customer's responsibility to ensure safety especially when combustible gases are being analyzed since the potential of gas leaks always exist.

The customer should ensure that the principles of operation of this equipment are well understood by the user. Misuse of this product in any manner, tampering with its components, or unauthorized substitution of any component may adversely affect the safety of this instrument.

Since the use of this instrument is beyond the control of Teledyne, no responsibility by Teledyne, its affiliates, and agents for damage or injury from misuse or neglect of this equipment is implied or assumed.

Table of Contents

Safety Messages	v
Introduction	1
1.1 Overview	1
1.2 Typical Applications	1
1.3 Main Features of the Analyzer	1
1.4 Model Designations	2
1.5 Front Panel (Operator Interface)	3
1.6 Front Access Door	4
1.7 Rear Panel (Equipment Interface)	5
Operational Theory	7
2.1 Introduction	7
2.2 Micro-Fuel Cell Sensor	7
2.2.1 Principles of Operation	7
2.2.2 Anatomy of a Micro-Fuel Cell	8
2.2.3 Electrochemical Reactions	10
2.2.4 The Effect of Pressure	11
2.2.5 Calibration Characteristics	11
2.3 Sample System	12
2.4 Electronics and Signal Processing	14
Installation	17
3.1 Unpacking the Analyzer	17
3.2 Mounting the Analyzer	17
3.3 Rear Panel Connections	18
3.3.1 Gas Connections	19
3.3.2 Electrical Connections	21
3.3.2.1 24VDC Input Power	21
3.3.2.2 50-Pin Equipment Interface Connector	21
3.3.2.3 RS-232 Port	28



3.3.2.4 Profibus Connector	29
3.4 Installing the Micro-Fuel Cell	29
3.5 Testing the System	30
Operation	31
4.1 Introduction	31
4.2 Start Up Screens	31
4.2.1 Diagnostic Screen	32
4.2.2 Factory Reset Screen	34
4.3 Main Screen	35
4.4 Menu Screen	37
4.5 System Screen	38
4.5.1 Password	39
4.5.2 Logout	42
4.5.3 Track/Hold Screen	43
4.5.4 Auto Cal Screen	46
4.5.5 Self Test	52
4.5.6 Flow Limit	52
4.5.7 VB Baud Rate Screen	55
4.5.8 Profibus Screen	58
4.5.8.1 Profibus Address	58
4.5.8.2 Profibus Status	60
4.5.8.3 Profibus Task	61
4.5.9 Analog Output	64
4.5.9.1 Range Identification	67
4.5.9.2 Concentration	68
4.5.10 More Screen	69
4.5.10.1 Serial Number	71
4.5.10.2 Negative Number	71
4.5.10.3 Stream Selection	72
4.5.10.4 Model Number	72
4.5.11 Version	72
4.5.12 System Status	73
4.5.13 Firmware Upgrade	74
4.6 The Range Function	75

4.6.1 Setting the Analog Output Ranges	75
4.6.2 Fixed Range Analysis	79
4.7 Alarm Function	80
4.7.1 Alarm Setpoint	83
4.7.2 HI/LOW Alarm	84
4.7.3 Alarm Defeat	84
4.7.4 Failsafe/Non-Failsafe Mode	85
4.7.5 Latching/Non-Latching Alarm	85
4.7.6 Alarm Status	86
4.8 The Zero and Span Functions	86
4.8.1 Zero Cal	87
4.8.1.1 Auto Mode Zeroing	89
4.8.1.2 Manual Mode Zeroing	91
4.8.2 Span Cal	94
4.8.2.1 Auto Mode Spanning	94
4.8.2.2 Span Manual Mode Run Screen	100
4.9 Maintenance Schedule	102
4.10 No Sensor Detection Feature, Sensor Fail	104
Maintenance	106
5.1 Routine Maintenance	106
5.2 Cell Replacement	106
5.2.1 Storing and Handling Replacement Cells	106
5.2.2 When to Replace a Cell	107
5.2.3 Removing the Micro-Fuel Cell	107
5.2.4 Installing a New Micro-Fuel Cell	110
5.3 Fuse Replacement	111
5.4 System Self Diagnostic Test	111
5.5 Major Internal Components	111
5.6 Cleaning	113
5.7 Troubleshooting	113
Appendix.....	115
A-1 Model 3000RS-TXL Specifications	115
A-2 Recommended 2-Year Spare Parts List	116
A-3 Drawing List	118

A.4 Application notes	118
A-5 Material Safety Data Sheet	122

List of Figures

Figure 1-1: Model 3000RS Front Panel.....	3
Figure 1-2: Model 3000RS Rear Panel	5
Figure 2-1: MFC and Cell Block (Front View of 3000RS with door open)	8
Figure 2-2: Micro-Fuel Cell.....	9
Figure 2-3: Cross Section of a Micro-Fuel Cell (not to scale).....	9
Figure 2-4: Characteristic Input/Output Curve for a Micro-Fuel Cell..	12
Figure 2-5: Piping Layout and Flow Diagram for Standard Model.	13
Figure 2-6: Flow Diagram.....	13
Figure 2-7: 3000RS Internal Electronic Component Location	14
Figure 2-8: Block Diagram of the Model 3000RS Electronics.....	16
Figure 3-1: Front Access Door	18
Figure 3-2: Rear Panel of the Model 3000RS	19
Figure 3-3: Equipment Interface Connector Pin Arrangement.....	22
Figure 3-4: Remote Probe Connections	27
Figure 3-5: FET Series Resistance	27
Figure 4-1: Analyze Screen Display	35
Figure 5-1: Cell Holder	108
Figure 5-3: Removing the Micro-Fuel Cell.....	109
Figure 5-4: Rear Panel Removal.....	112

List of Tables

Table 3-1: Analog Output Connections Pin Function.....	22
Table 3-2: Alarm Relay Contact Pins	24
Table 3-3: Remote Calibration Connections.....	25
Table 3-4: Range ID Relay Connections	26
Table 3-5: Commands via RS-232 Input	28
Table 5-1: Self Test Failure Codes.....	111

1 Introduction

1.1 Overview

The Teledyne Analytical Instruments Model 3000RS-XL (also referred to as “the Analyzer”) is a redesigned compact version of the touchscreen model 3000TS Trace Oxygen Analyzer. It is a versatile microprocessor-based instrument for detecting oxygen at the parts-per-million (ppm) level in a variety of gases. This manual covers the Model 3000RS-TXL general purpose flush-panel rack-mount units only. These units are for indoor use in a nonhazardous environment.

1.2 Typical Applications

A few typical applications of the Model 3000RS-TXL are:

- Monitoring inert gas blanketing
- Air separation and liquefaction
- Chemical reaction monitoring
- Semiconductor manufacturing
- Petrochemical process control
- Quality assurance
- Gas analysis certification.

1.3 Main Features of the Analyzer

The Model 3000RS-TXL Trace Oxygen Analyzer is sophisticated yet simple to use. The main features of the analyzer include:

- A compact 320x240 touch sensitive LCD display screen, driven by microprocessor electronics that continuously prompts and informs the operator.
- UART communication
- High resolution, accurate readings of oxygen content from low ppm levels through 25%. Large, bright, meter readout.
- Redesigned nylon cell block.

- Advanced Micro-Fuel Cell, designed for trace analysis, has a one-year warranty and an expected lifetime of two years.
- Versatile analysis over a wide range of applications.
- Microprocessor based electronics.
- Three user definable output ranges (from 0-10 ppm through 0- 250,000 ppm) allow best match to users process and equipment.
- Digital flowmeter allows convenient on-screen flow monitoring from the interface panel and includes a user settable low flow alarm.
- Air-calibration range for convenient spanning at 20.9 %.
- Auto Ranging allows analyzer to automatically select the proper preset range for a given measurement. Manual override allows the user to lock onto a specific range of interest.
- Two adjustable concentration alarms, low flow alarm, and a system failure alarm.
- Extensive self-diagnostic testing, at startup and on demand, with continuous power-supply monitoring.
- CE Compliance.
- RS-232 serial digital port for use with a computer or other digital communication device.
- Profibus port.
- LAN port
- Two analog outputs: two for measurement (0–1 VDC or Isolated 4–20 mA DC) and two for range identification.
- Compact design with easy access to cell compartment and electronics.

1.4 Model Designations

3000RS-XL: Standard model.

3000RS-XL-C: In addition to all standard features, this model also has separate ports for zero and span gases, and built-in control valves. The internal valves are entirely under the control of the 3000RS-XL

electronics, to automatically switch between gases in synchronization with the analyzer's operations.

1.5 Front Panel (Operator Interface)

The standard 3000RS-XL is housed in a rugged case with a front panel mounted touch screen display that handles all gas controls and displays. See Figure 1-1. The touch screen panel has a touch sensitive button to access various menus and sub menus for setting up and operating the analyzer. It has a digital flowmeter display showing both the current flow and any fluctuation in flow via a simulated onscreen flowmeter. The analyzer panel has a large display area for data display, process variables, and other operational details depending on the function selected or current alarm status.

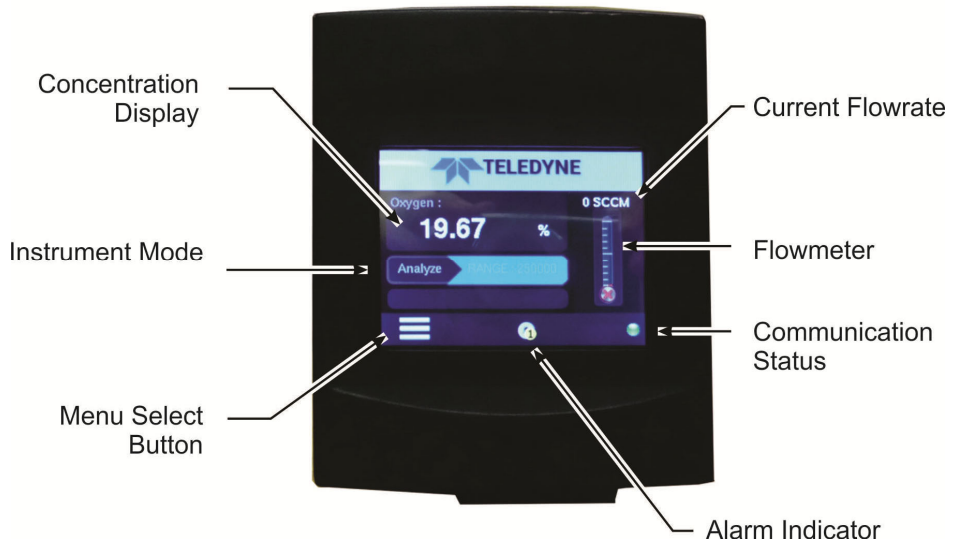

Figure 1-1: Model 3000RS-TXL Front Panel

- **Concentration Display:**

When in Analysis mode, the display region indicates a continuous readout from 0 ppm through 25% automatically switching from ppm to percent when the measured value rises above 10,000 ppm. It is accurate across all analysis ranges without the discontinuity inherent in analog range switching.

The display screen, depending on the function selected, will also display values, options, and messages that give the operator immediate feedback.

- **Instrument Mode:**
Identifies the current mode of the analyzer: Analyze Mode or System Mode.
- **Current Flowrate:**
Reports the current flowrate in units of standard cubic centimeters per minute (SCCM).
- **Flowmeter:**
Shows the current flow values on a simulated flowmeter from 0 to 100%.
- **Alarm Indicator:**
Indicates whether an alarm is triggered.

Alarm 1



Alarm 2



- **Communication Status:**
LAN status icon displays when the LAN connection established.



1.6 Front Access Door

For access to the cell holder and the Micro-Fuel Cell, the front panel door is hinged and swings down after pressing the top latch button.

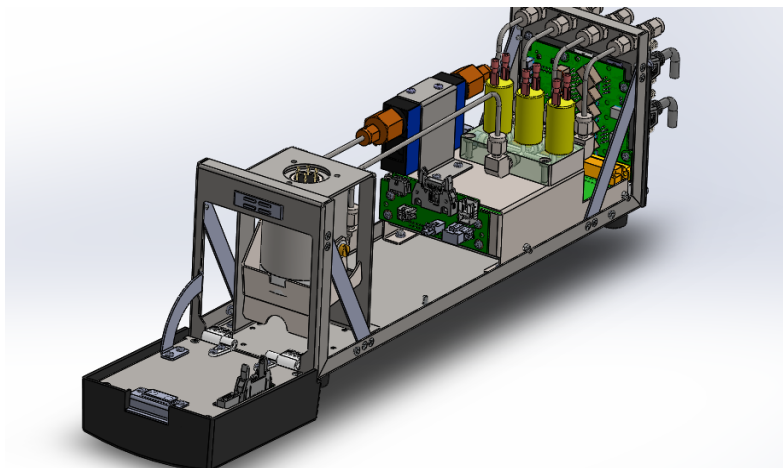

1.7 Rear Panel (Equipment Interface)

The rear panel, shown in Figure 1-2, contains the gas and electrical connectors for external inlets and outlets. The connectors are described briefly here and in detail in the *Installation* chapter of this manual.

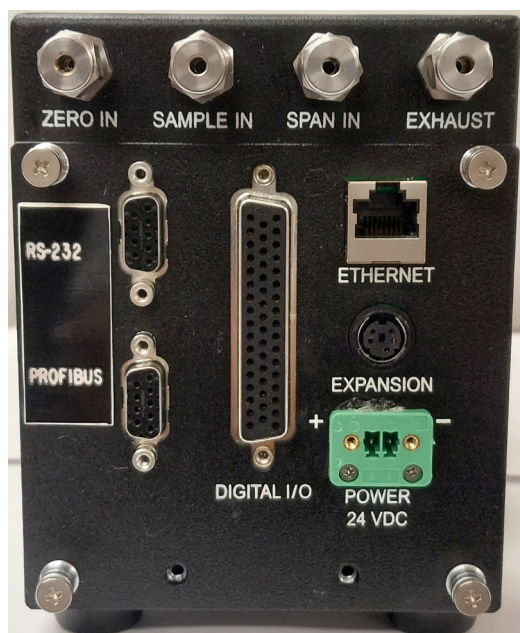

Figure 1-2: Model 3000RS-TXL Rear Panel

Power Connection: 24VDC power source.

Gas Connections: Sample, exhaust, and optional Span and Zero.

RS-232: Serial digital concentration signal output and control input.

Profibus: Connection for Profibus communication.

LAN: Serial digital communications for local network access.

50-Pin Equipment Interface Port:

- Analog Outputs: 0–1 VDC concentration plus 0-1 VDC range ID, and isolated 4–20 mA DC plus 4-20 mA DC range ID.
- Alarm Connections: 2 concentration alarms and 1 system alarm.
- Remote Span/Zero Digital inputs allow external control of analyzer calibration.
- Calibration Contact: To notify external equipment that instrument is being calibrated and readings are not monitoring sample.
- Range ID Contacts: Four separate, dedicated, range relay contacts. Low, Medium, High, Cal.
- Network I/O: Serial digital communications for local network access. For future expansion. Not implemented at this printing.

Optional:

Calibration Gas Ports (Auto Cal Option) Separate fittings for zero, span and sample gas input, and internal valves for automatically switching the gases.

Note: If you require highly accurate Auto-Cal timing, use external Auto-Cal control where possible. The internal clock in the Model 3000RS-TXL is accurate to 2-3 %. Accordingly, internally scheduled calibrations can vary 2-3 % per day.

2 Operational Theory

2.1 Introduction

The analyzer is composed of three subsystems:

1. Micro-Fuel Cell Sensor
2. Sample System
3. Electronic Signal Processing, Display and Control

The sample system is designed to accept the sample gas and transport it through the analyzer without contaminating or altering the sample prior to analysis. The Micro-Fuel Cell is an electrochemical galvanic device that translates the amount of oxygen present in the sample into an electrical current. The electronic signal processing, display and control subsystem simplifies operation of the analyzer and accurately processes the sampled data. The microprocessor controls all signal processing, input/output and display functions for the analyzer.

2.2 Micro-Fuel Cell Sensor

2.2.1 Principles of Operation

The oxygen sensor used in the Model 3000RS-TXL Analyzer is a Micro-Fuel Cell designed and manufactured by Analytical Instruments. It is a sealed plastic disposable electrochemical transducer and installs easily from the front door in a compartment with a threaded sample cell holder. See Figure 2-1.

The active components of the Micro-Fuel Cell are a cathode, an anode, and the 15% aqueous KOH electrolyte in which they are immersed. The cell converts the energy from a chemical reaction into an electrical current in an external electrical circuit. Its action is similar to that of a battery.

There is, however, an important difference in the operation of a battery as compared to the Micro-Fuel Cell: In the battery, all reactants are stored within the cell, whereas in the Micro-Fuel Cell, one of the reactants (oxygen) comes from outside the device as a constituent of the

sample gas being analyzed. The Micro-Fuel Cell is therefore a hybrid between a battery and a true fuel cell. (All of the reactants are stored externally in a true fuel cell.)

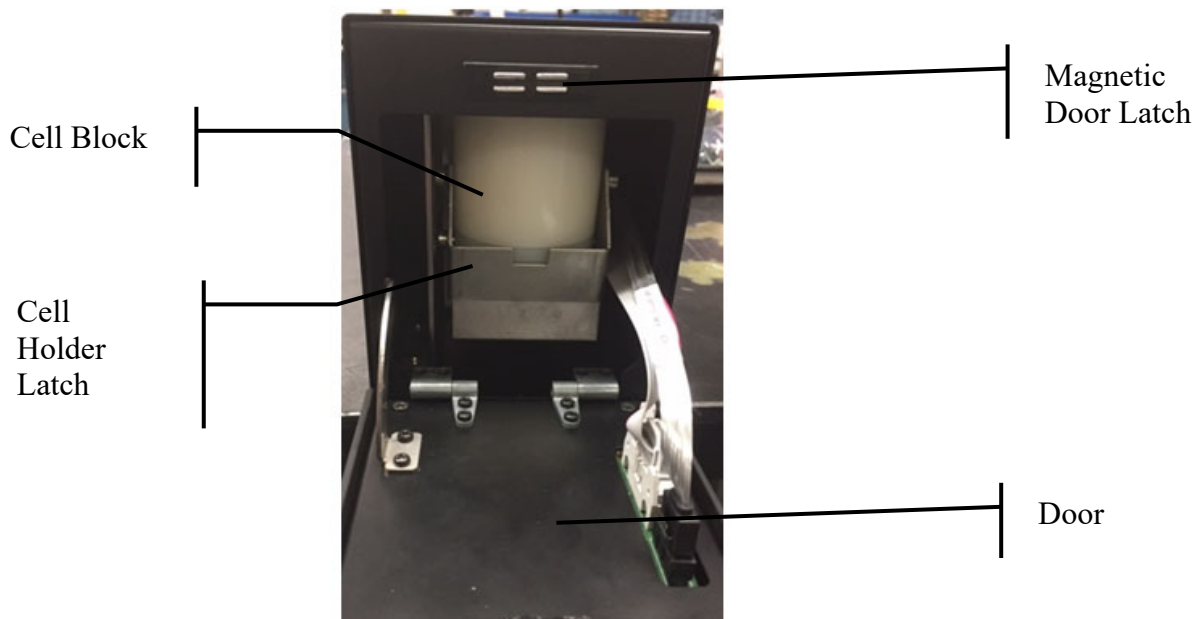

Figure 2-1: MFC and Cell Block (Front View of 3000RS-TXL with door open)

2.2. Anatomy of a Micro-Fuel Cell

The Micro-Fuel Cell is a cylinder only 1 1/4 inches in diameter and 1 1/4 inches thick. It is made of an extremely inert plastic, which can be placed confidently in practically any environment or sample stream. It is effectively sealed, although one end is permeable to oxygen in the sample gas. The other end of the cell is a contact plate consisting of two concentric foil rings. The rings mate with spring-loaded contacts in the sensor block assembly and provide the electrical connection to the rest of the analyzer. Figure 2-2 illustrates the external features.

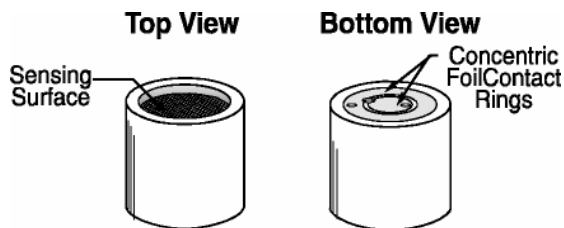

Figure 2-2: Micro-Fuel Cell

Refer to Figure 2-3: *Cross Section of a Micro-Fuel Cell*, which illustrates the following internal description.

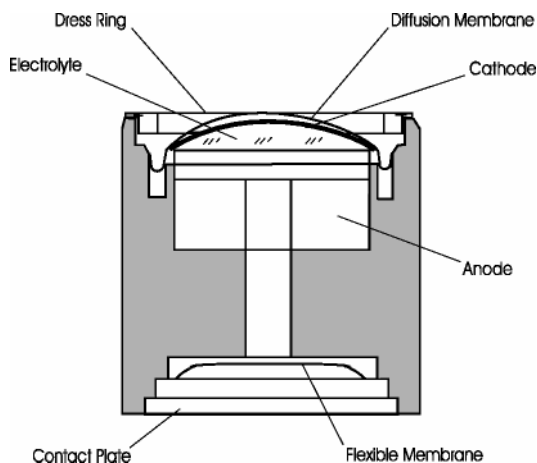

Figure 2-3: Cross Section of a Micro-Fuel Cell (not to scale)

At the top end of the cell is a diffusion membrane of Teflon®, whose thickness is very accurately controlled. Beneath the diffusion membrane lies the oxygen sensing element—the cathode—with a surface area almost 4 cm². The cathode has many perforations to ensure sufficient wetting of the upper surface with electrolyte, and it is plated with an inert metal.

The anode structure is below the cathode. It is made of lead and has a proprietary design which is meant to maximize the amount of metal available for chemical reaction.

At the rear of the cell, just below the anode structure, is a flexible membrane designed to accommodate the internal volume changes that occur throughout the life of the cell. This flexibility assures that the sensing membrane remains in its proper position, keeping the electrical output constant.

The entire space between the diffusion membrane, above the cathode, and the flexible rear membrane, beneath the anode, is filled with electrolyte. Cathode and anode are submerged in this common pool. They each have a conductor connecting them to one of the external contact rings on the contact plate, which is on the bottom of the cell.

2.2.3 Electrochemical Reactions

The sample gas diffuses through the Teflon membrane. Any oxygen in the sample gas is reduced on the surface of the cathode by the following HALF REACTION:



(Four electrons combine with one oxygen molecule—in the presence of water from the electrolyte—to produce four hydroxyl ions.)

When the oxygen is reduced at the cathode, lead is simultaneously oxidized at the anode by the following HALF REACTION:

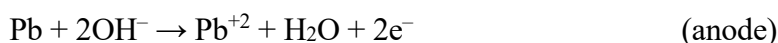

(Two electrons are transferred for each atom of lead that is oxidized. Therefore, it takes two of the above anode reactions to balance one cathode reaction and transfer four electrons.)

The electrons released at the surface of the anode flow to the cathode surface when an external electrical path is provided. The current is proportional to the amount of oxygen reaching the cathode. It is measured and used to determine the oxygen concentration in the gas mixture.

The overall reaction for the fuel cell is the SUM of the half reactions above, or:

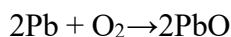

(These reactions will hold as long as no gaseous components capable of oxidizing lead—such as iodine, bromine, chlorine and fluorine—are present in the sample.)

The output of the fuel cell is limited by (1) the amount of oxygen in the cell at the time and (2) the amount of stored anode material.

In the absence of oxygen, no current is generated.

2.2.4 The Effect of Pressure

To determine the amount of oxygen present in the sample in parts-per-million or a percentage of the gas mixture, it is necessary that the sample diffuse into the cell under constant pressure.

If the total pressure increases, the rate that oxygen reaches the cathode through the diffusing membrane will also increase. The electron transfer, and therefore the external current, will increase, even though the oxygen concentration of the sample has not changed. It is therefore important that the sample pressure at the fuel cell (usually vent pressure) remain relatively constant between calibrations.

2.2.5 Calibration Characteristics

Given that the total pressure of the sample gas on the surface of the Micro-Fuel Cell input is constant, a convenient characteristic of the cell is that the current produced in an external circuit is directly proportional to the rate at which oxygen molecules reach the cathode, and this rate is directly proportional to the concentration of oxygen in the gaseous mixture. In other words it has a linear characteristic curve, as shown in Figure 2-4. Measuring circuits do not have to compensate for nonlinearities.

In addition, since there is zero output in the absence oxygen, the characteristic curve has close to an absolute zero (within ± 1 ppm oxygen). In practical application, zeroing may still used to compensate for the combined zero offsets of the cell and the electronics. (The electronics is zeroed automatically when the instrument power is turned on.)

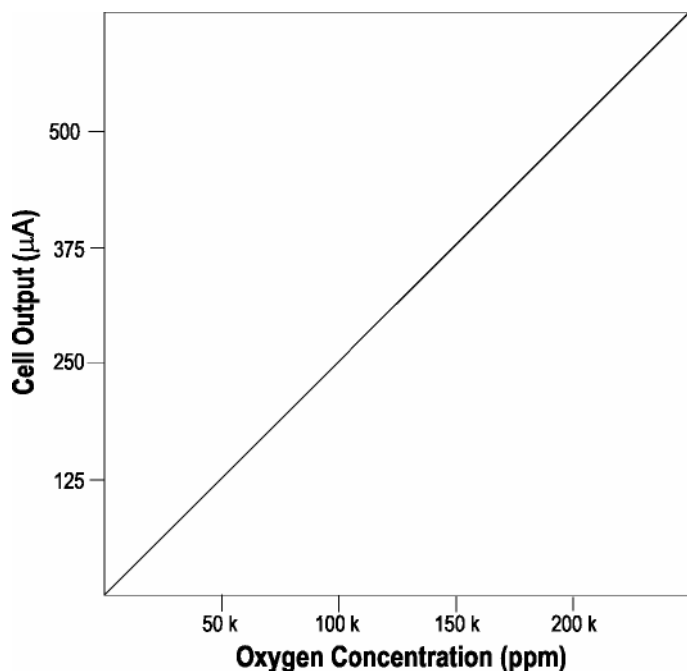

Figure 2-4: Characteristic Input/Output Curve for a Micro-Fuel Cell

2.3 Sample System

The sample system delivers gases to the Micro-Fuel Cell sensor from the analyzer rear panel inlet. Depending on the mode of operation either sample or calibration gas is delivered.

The Model 3000RS-TXL sample system is designed and fabricated to ensure that the oxygen concentration of the gas is not altered as it travels through the sample system. The sample encounters almost no dead space. This minimizes residual gas pockets that can interfere with trace analysis.

The sample system for the standard instrument incorporates 1/8-inch tube fittings for sample inlet and outlet connections at the rear panel. For metric system installations, 6 mm adapters are available if required. The sample or calibration gas flows through a digital flow sensor which reports the flow downstream from the cell. Figure 2-5 shows the internal piping layout for the standard model.

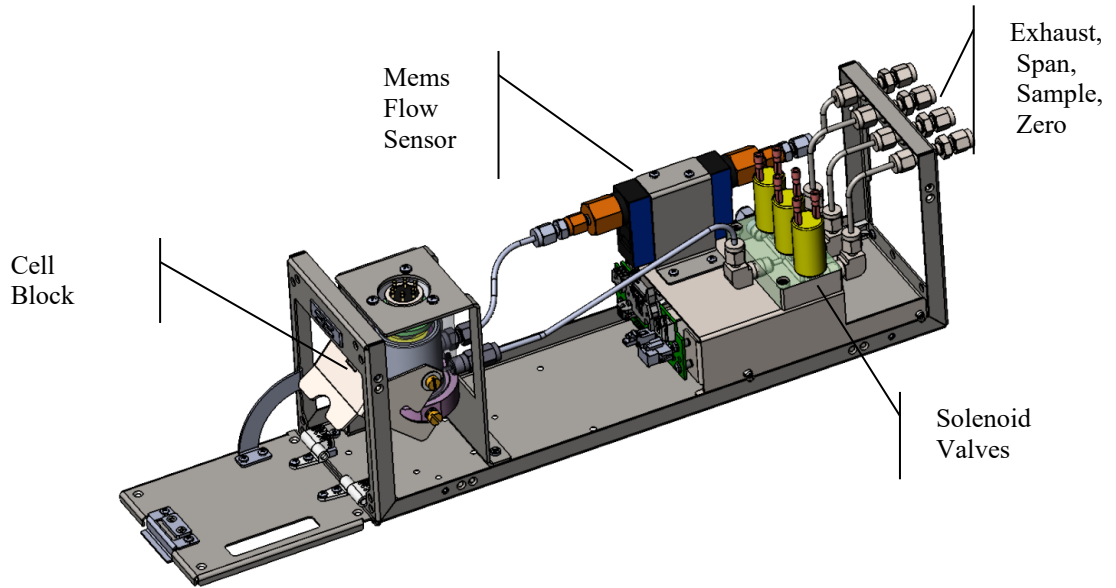

Figure 2-5: Piping Layout and Flow Diagram for Standard Model

Figure 2-6 is the flow diagram for the sampling system. In the standard instrument, calibration gases (zero and span) can be connected directly to the Sample In port by teeing to the port with appropriate valves. The shaded portion of the diagram shows the components added when the -C option is ordered. The valving is installed inside the 3000RS-XL-C enclosure and is regulated by the instrument's internal electronics.

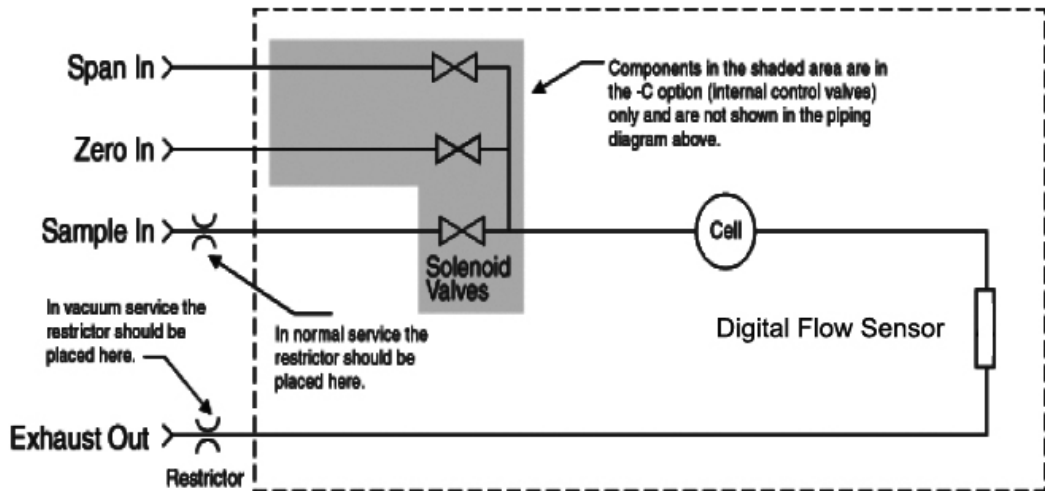

Figure 2-6: Flow Diagram

2.4 Electronics and Signal Processing

The Model 3000RS-XL Trace Oxygen Analyzer uses a microcontroller with to control all signal processing, input/output, and display functions for the analyzer.

The signal processing electronics including the microprocessor, analog to digital, and digital to analog converters are located on the motherboard at the bottom of the case. The preamplifier board is mounted on top of the motherboard. The motherboard slides into the plate assembly as shown in Figure 2-7. The rear panel board plugs into a connector at the rear of the motherboard. An interface board is mounted at the front of the plate assembly and accepts the connectors from the sensor block, MEMEs sensor and auto calibration solenoid valves. Figure 2-8 is a block diagram of the Analyzer electronics.

In the presence of oxygen, the cell generates a current. A current to voltage amplifier converts this current to a voltage, which is amplified in the second stage amplifier.

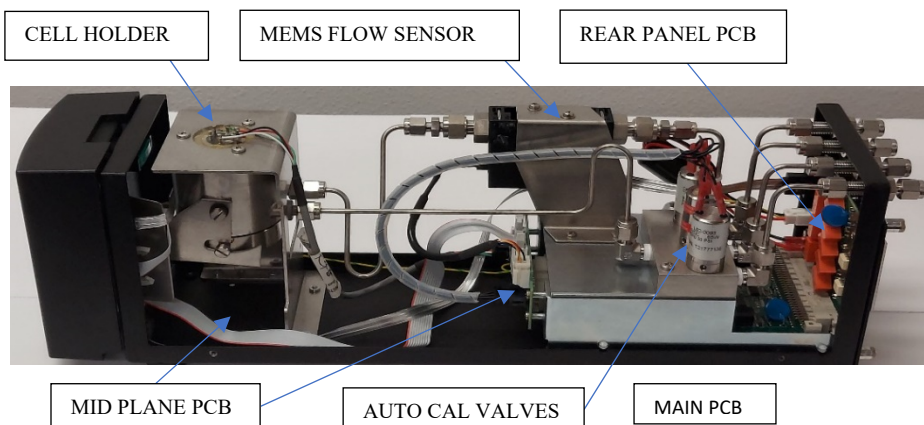

Figure 2-7: 3000RS-TXL Internal Electronic Component Location

The second stage amplifier also supplies temperature compensation for the oxygen sensor output. This amplifier circuit incorporates a thermistor, which is physically located in the cell block. The thermistor is a temperature dependent resistance that changes the gain of the amplifier in proportion to the temperature changes in the block. This change is inversely proportional to the change in the cell output due to the same

temperature changes. The result is a signal that is temperature independent. The output from the second stage amplifier is sent to an 18-bit analog to digital converter controlled by the microprocessor.

The digital concentration signal along with input from the control panel is processed by the microprocessor, and appropriate control signals are directed to the display, alarms, and communications port. The same digital information is also sent to a 12-bit digital to analog converter that produces the 4-20 mA DC and the 0-1 VDC analog concentration signal outputs, and the analog range ID outputs.

Signals from the power supply are also monitored, and through the microprocessor, the system failure alarm is activated if a malfunction is detected.

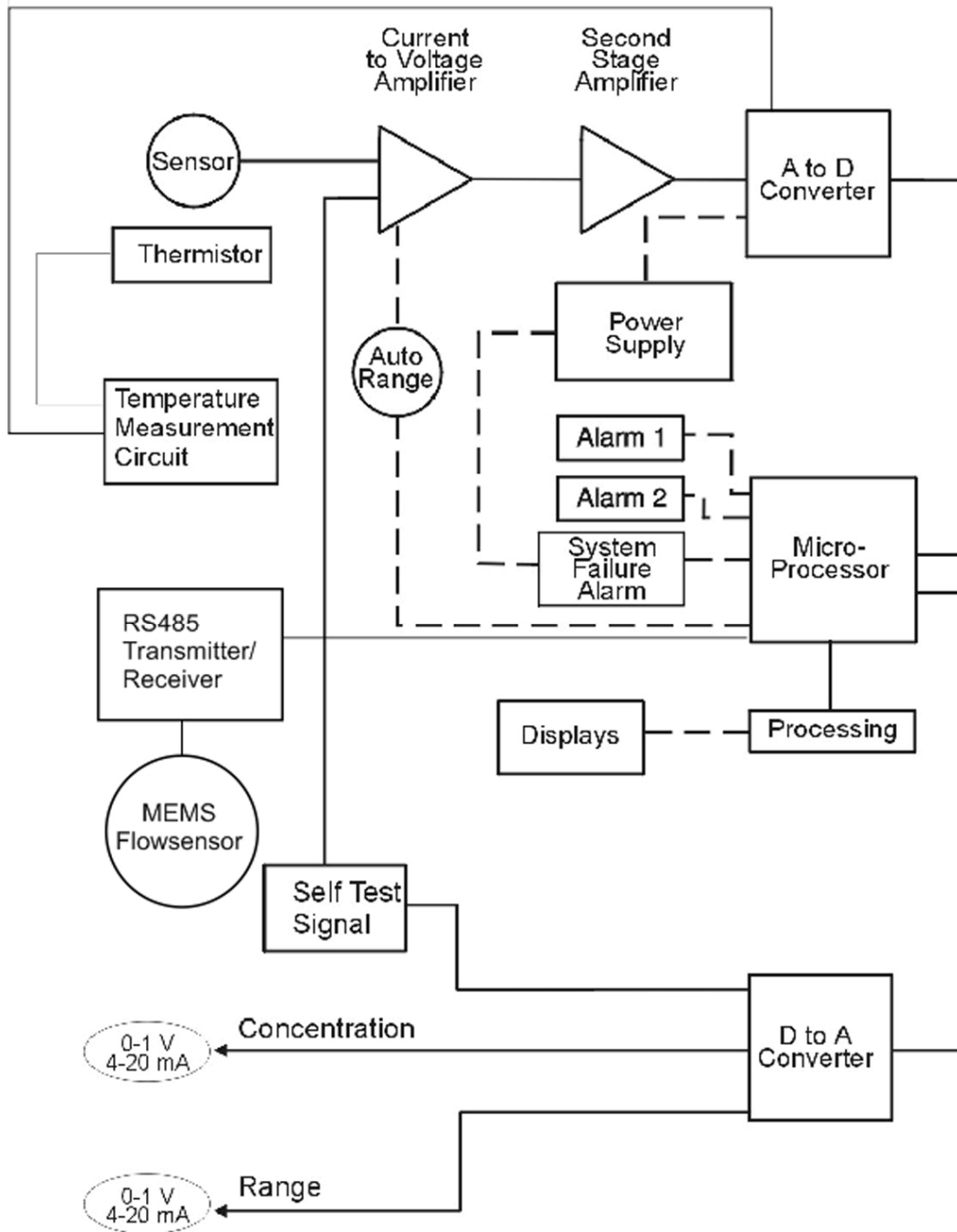

Figure 2-8: Block Diagram of the Model 3000RS-TXL Electronics

3 Installation

CAUTION: PLEASE REVIEW THE RISKS/HAZARDS SAFETY MESSAGES IN THE FRONT MATTER OF THIS MANUAL BEFORE INSTALLING, COMMISSIONING, OR OPERATING THIS INSTRUMENT.



Installation of the Model 3000RS-TXL Analyzer includes:

1. Unpacking
2. Mounting
3. Gas connections
4. Electrical connections
5. Installing the Micro-Fuel Cell
6. Testing the system.

3.1 Unpacking the Analyzer

Although the analyzer is shipped complete, certain parts, such as fuses and sensors, are wrapped separately to be installed on site as part of the installation. Carefully unpack the analyzer and inspect it for damage. Immediately report any damage or shortages to the shipping agent.

3.2 Mounting the Analyzer

The Model 3000RS-TXL is for indoor use in a general-purpose area. It is NOT for hazardous environments of any type.

The RS series analyzers are designed to mount in a 3U size 19" relay chassis. A standard RS analyzer is supplied without chassis or cover. The optional 19" chassis can be supplied configured for one to four RS analyzers. There is also a single cover option that includes the cover and feet for bench top use of a single RS analyzer.

The touch screen operator control buttons are mounted on the front panel, which is hinged at the bottom and provides access to the sensor

and cell block inside the instrument. The front door has a magnetic latch on the top. When the top is pulled toward the front, the door will open downwards exposing the cell block compartment. See Figure 3-1.



Figure 3-1: Front Access Door

3.3 Rear Panel Connections

Figure 3-2 shows the Model 3000RS-TXL rear panel. There are ports for gas, power, and equipment interface. The Zero in and Span in ports are not included on the standard model but are available as options.

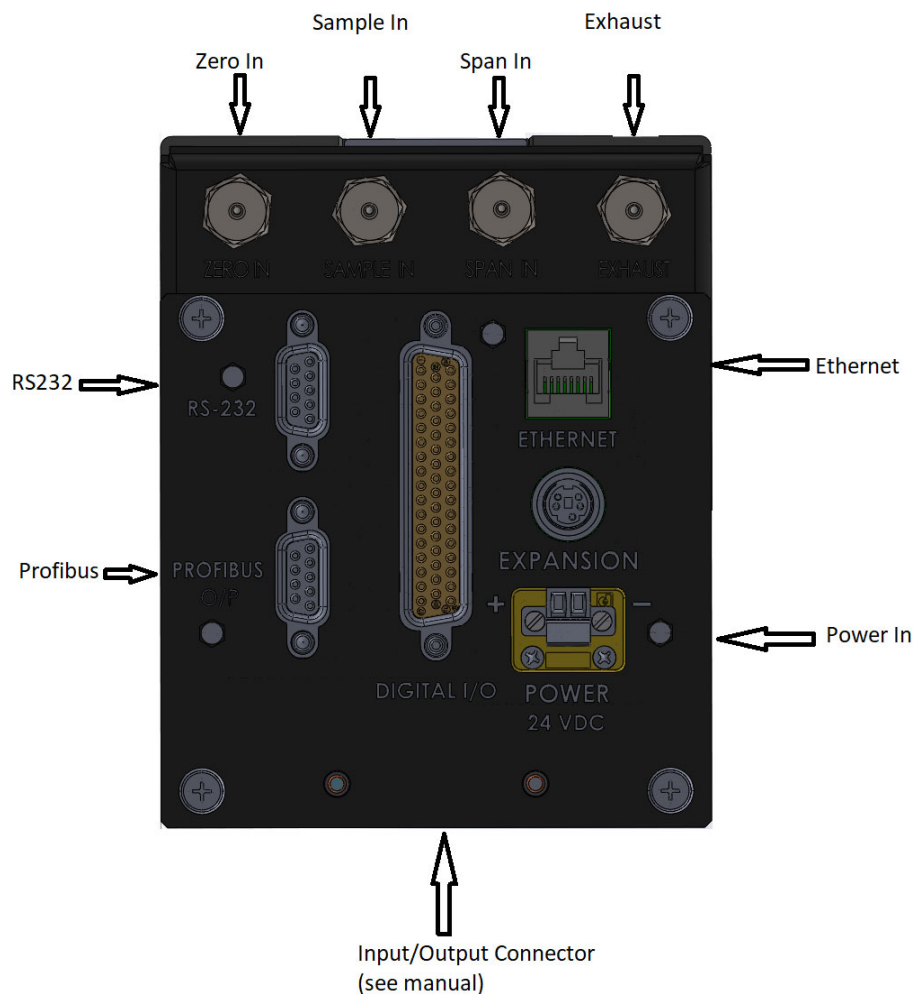

Figure 3-2: Rear Panel of the Model 3000RS-TXL

3.3.1 Gas Connections

Before using this instrument, it should be determined if the unit will be used for pressurized service or vacuum service and low pressure applications. The gas ports are 1/8". The analyzer does not have flow control, therefore a needle valve or an orifice/restrictor is going to be needed to control the flow into the analyzer. If the 3000RS-TXL has three inlet ports, for zero, sample, and span, then each port will need its own flow control device. The restrictor for low pressure (for pressure less than 5 psig) or for high pressure applications (5-50psig) should set

flows in the range of 500 to 2000 ccm during normal operating pressures.

For vacuum service (5-10 in Hg), the low pressure restrictor can be used but it is attached to the **Exhaust Out** port.

WARNING: OPERATING THE UNIT WITHOUT RESTRICTORS OR ANY FLOW CONTROL CAN CAUSE DAMAGE TO THE MICRO-FUEL CELL.



The unit is manufactured with 1/8 inch tube fittings, For a safe connection:

1. Insert the tube into the tube fitting, and finger-tighten the nut until the tubing cannot be rotated freely, by hand, in the fitting. (This may require an additional 1/8 turn beyond finger-tight.)
2. Hold the fitting body steady with a backup wrench, and with another wrench rotate the nut another 1-1/4 turns.

SAMPLE IN:

In the standard model, gas connections are made at the SAMPLE IN and EXHAUST OUT connections at the top of the rear panel. In the standard model (without auto calibration) the calibration gases must be tee'd into the Sample inlet with appropriate valves. The standard analyzer uses 1/8" gas connectors.

The gas pressure in should be reasonably regulated. Pressures between 2 and 50 psig are acceptable provided the pressure, once established, will keep the front panel simulated flowmeter display reading in an acceptable range (100 to 200 CCM). For non-pressurized sample or very low pressure, (2 psig or less) vacuum service plumbing is recommended. Exact figures will depend on your process.

If greater flow is required for improved response time, install a bypass in the sampling system upstream of the analyzer input.

EXHAUST OUT:

Exhaust connections must be consistent with the hazard level of the constituent gases. Check Local, State, and Federal laws, and ensure that the exhaust stream vents to an appropriately controlled area if required.



ZERO IN and SPAN IN (Optional):

These are additional ports for inputting span gas and zero gas and are included when the instrument is ordered with the Auto Calibration feature. The Auto Calibration feature uses electrically operated internal valves for automatic switching between sample and calibration gases. These valves are completely under control of the 3000RS-TXL Electronics. They can be externally controlled only indirectly through the Remote Cal Inputs, described below.

Pressure, flow, and safety considerations are the same as prescribed for the SAMPLE IN inlet, above.

3.3.2 Electrical Connections

For safe connections, no uninsulated wiring should be able to come in contact with fingers, tools or clothing during normal operation.

CAUTION: **USE SHIELDED CABLES. ALSO, USE PLUGS THAT PROVIDE EXCELLENT EMI/RFI PROTECTION. THE PLUG CASE MUST BE CONNECTED TO THE CABLE SHIELD, AND IT MUST BE TIGHTLY FASTENED TO THE ANALYZER WITH ITS FASTENING SCREWS. ULTIMATELY, IT IS THE INSTALLER WHO ENSURES THAT THE CONNECTIONS PROVIDE ADEQUATE EMI/RFI SHIELDING.**



3.3.2.1 24VDC INPUT POWER

The analyzer is powered using a 24 VDC source. Insert the power supply connector into the receptacle shown in Figure 3-2. Use external fuses for each 3000RS-TXL series instrument as 24 vdc power is distributed. Fuse recommendation is 0.5 A 250 V slow blow.

CAUTION: **POWER IS APPLIED TO THE INSTRUMENT'S CIRCUITRY AS LONG AS THE INSTRUMENT IS CONNECTED TO THE POWER SOURCE.**



3.3.2.2 50-PIN EQUIPMENT INTERFACE CONNECTOR

Figure 3-3 shows the pin layout of the Equipment Interface connector. The arrangement is shown as seen when the viewer faces the rear panel of the analyzer. The pin numbers for each input/output

function are given where each function is described in the paragraphs below.

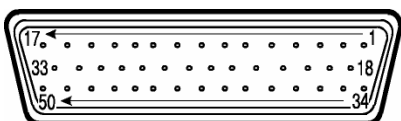

Figure 3-3: Equipment Interface Connector Pin Arrangement

Analog Outputs: There are four DC output signal pins—two pins per output. The outputs are either 0-1 vdc or 4-20 mA dc. The choice is configurable through the front panel Analog Output function. For polarity, see Table 3-1. The outputs are:

- 0–1 VDC % of Range: Voltage rises linearly with increasing oxygen, from 0 V at 0 ppm to 1 V at full scale ppm. (Full scale = 100% of programmable range.)
- 0–1 VDC Range ID: 0.25 V = Low Range, 0.5 V = Medium Range, 0.75 V = High Range, 1 V = Air Cal Range.
- 4–20 mA DC % Range: Current increases linearly with increasing oxygen, from 4 mA at 0 ppm to 20 mA at full scale ppm. (Full scale = 100% of programmable range.)
- 4–20 mA DC Range ID: 8 mA = Low Range, 12 mA = Medium Range, 16 mA = High Range, 20 mA = Air Cal Range.

Table 3-1: Analog Output Connections Pin Function

Pin	Function
3	+ Range ID, 4-20 mA, floating
4	– Range ID, 4-20 mA, floating
5	+ % Range, 4-20 mA, floating
6	– % Range, 4-20 mA, floating
8	+ Range ID, 0-1 VDC

Pin	Function
23	– Range ID, 0-1 VDC, negative ground
24	+ % Range, 0-1 VDC
7	– % Range, 0-1 VDC, negative ground

Alarm Relays: The nine alarm-circuit connector pins connect to the internal alarm relay contacts. Each set of three pins provides one set of Form C relay contacts. Each relay has both normally open and normally closed contact connections. The contact connections are shown in Table 3-2. They are capable of switching up to 100V AC/DC at 1 Amp (Secondary power Pollution DEGREE).

The connectors are:

Threshold Alarm 1:

- Can be configured as high (actuates when concentration is above threshold), or low (actuates when concentration is below threshold).
- Can be configured as failsafe or non-failsafe.
- Can be configured as latching or non-latching.
- Can be configured out (defeated).

Threshold Alarm 2:

- Can be configured as high (actuates when concentration is above threshold), or low (actuates when concentration is below threshold).
- Can be configured as failsafe or non-failsafe.
- Can be configured as latching or non-latching.
- Can be configured out (defeated).

System Alarm:

- Actuates when DC power supplied to circuits is unacceptable in one or more parameters. Permanently configured as failsafe and latching. Cannot be defeated. Actuates if self-test fails.
- Alarm 1 and Alarm 2 are configured from the Alarm configuration screen.

Further detail can be found in Chapter 4 Section 4-7.

Table 3-2: Alarm Relay Contact Pins

Pin	Contact
45	Threshold Alarm 1, normally closed contact
28	Threshold Alarm 1, moving contact
46	Threshold Alarm 1, normally open contact
42	Threshold Alarm 2, normally closed contact
44	Threshold Alarm 2, moving contact
43	Threshold Alarm 2, normally open contact
36	System Alarm, normally closed contact
20	System Alarm, moving contact
37	System Alarm, normally open contact

Digital Remote Cal Inputs: Accept 0 V (off) or 24 VDC (on) inputs for remote control of calibration. (See *Remote Calibration Protocol* below.) See Table 3-3 for pin connections.

- Zero:** Floating input. 5 to 24 V input across the + and – pins places the analyzer into the Zero mode. Either side may be grounded at the source of the signal. 0 to 1 volt across the terminals allows Zero mode to terminate when done. A synchronous signal must open and close the external zero valve appropriately. See Remote Probe Connector. (The –C option internal valves operate automatically.)
- Span:** Floating input. 5 to 24 V input across the + and – pins places the analyzer into the Span mode. Either side may be grounded at the source of the signal. 0 to 1 volt across the terminals allows Span mode to terminate when done. A synchronous signal must open and close external span valve appropriately. See Figure 3-4 Remote Probe Connector. (The –C option internal valves operate automatically.)

Cal Contact: This relay contact is closed while analyzer is spanning and/or zeroing. (See *Remote Calibration Protocol* below.)

Table 3-3: Remote Calibration Connections

Pin	Function
9	+ Remote Zero
11	– Remote Zero
10	+ Remote Span
12	– Remote Span
40	Cal Contact
41	Cal Contact

Remote Calibration Protocol: To properly time the Digital Remote Cal Inputs to the Model 3000RS-TXL Analyzer, the customer's controller must monitor the Cal Relay Contact.

When the contact is OPEN, the analyzer is analyzing, the Remote Cal Inputs are being polled, and a zero or span command can be sent.

When the contact is CLOSED, the analyzer is already calibrating. It will ignore your request to calibrate, and it will not remember that request.

Once a zero or span command is sent, and acknowledged (contact closes), release it. If the command is continued until after the Zero or Span is complete, the calibration will repeat, and the Cal Relay Contact (CRC) will close again.

For example:

1. Test the CRC. When the CRC is open, Send a zero command until the CRC closes (The CRC will quickly close.)
2. When the CRC closes, remove the zero command.
3. When CRC opens again, send a span command until the CRC closes. (The CRC will quickly close.)
4. When the CRC closes, remove the span command.

When CRC opens again, zero and span are done, and the sample is being analyzed.

Note: The Remote Valve connections (described below) provides signals to ensure that the zero and span gas valves will be controlled synchronously. If you have the –C Internal valve option—which includes additional zero and span gas inputs— the 3000RS-TXL automatically regulates the zero, span and sample gas flow.

Range ID Relays: Four dedicated Range ID relay contacts. The first three ranges are assigned to relays in ascending order—Low range is assigned to Range 1 ID, Medium range is assigned to Range 2 ID, and High range is assigned to Range 3 ID. The fourth range is reserved for the Air Cal Range (25%). Table 3-4 lists the pin connections.

Table 3-4: Range ID Relay Connections

Pin	Function
21	Range 1 ID Contact
38	Range 1 ID Contact
22	Range 2 ID Contact
39	Range 2 ID Contact
19	Range 3 ID Contact
18	Range 3 ID Contact
34	Range 4 ID Contact (Air Cal)
35	Range 4 ID Contact (Air Cal)

Network I/O: A serial digital input/output for local network protocol. At this printing, this port is not yet functional. It is to be used for future options to the instrument. Pins 13 (+) and 29 (–).

Remote Valve Connections: The 3000RS-TXL is a single-chassis instrument, which has no Remote Valve Unit. Instead, the Remote Valve connections are used as a method for directly controlling external sample/zero/span gas valves. See Figure 3-4.

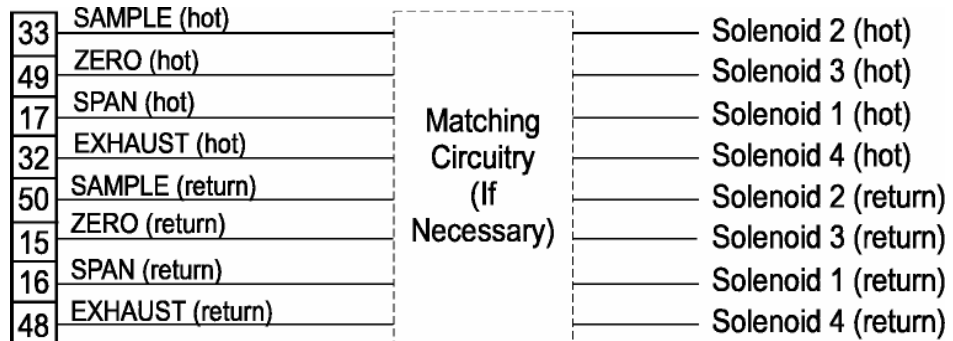

Figure 3-4: Remote Probe Connections

The voltage from these outputs is nominally 0 V for the OFF and 15 VDC for the ON conditions. The maximum combined current that can be pulled from these output lines is 100 mA. (If two lines are ON at the same time, each must be limited to 50 mA, etc.) If more current and/or a different voltage is required, use a relay, power amplifier, or other matching circuitry to provide the actual driving current.

In addition, each individual line has a series FET with a nominal ON resistance of 5 ohms (9 ohms worst case). This can limit the obtainable voltage, depending on the load impedance applied. See Figure 3-5.

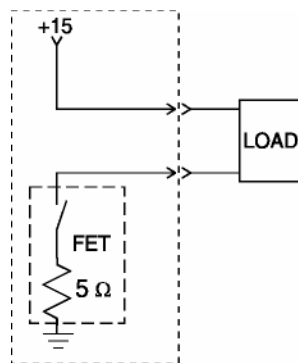

Figure 3-5: FET Series Resistance

3.3.2.3 RS-232 PORT

The digital signal output is a standard, full duplex RS-232 serial communications port used to connect the analyzer to a computer, terminal, or other digital device. It requires a standard 9-pin D connector.

The output data is status information, in digital form, updated every two seconds for Standard mode of serial communication (see section 4.3.11). Status is reported in the following order for Standard mode:

- The concentration in ppm or percent
- The range in use (HI, MED, LO)
- The span of the range (0-100 ppm, etc)
- Which alarms—if any—are disabled (AL-x DISABLED)
- Which alarms—if any—are tripped (AL-x ON).

Each status output is followed by a carriage return and line feed.

Three input functions using RS-232 have been implemented to date. They are described in Table 3-5.

Table 3-5: Commands via RS-232 Input

Command	Description
as <enter>	Immediately starts an autospan.
az <enter>	Immediately starts an autozero.
st <enter>	Toggling input. Stops/Starts any status message output from the RS-232, until st <enter> is sent again.

The RS-232 protocol allows some flexibility in its implementation. Table 3-6 lists certain RS-232 values that are required by the 3000RS-TXL implementation.

Table 3-6: Required RS-232 Options

Parameter	Setting
Baud	9600
Byte	8 bits

Parity	None
Stop Bits	1
Message Interval	2 seconds. When CRC opens again, zero and span are done,

The other mode of serial communication is “Profi” and this is used when analyzer connects to Teledyne Analytical Profibus Adapter board (TAPA board) or a Teledyne Analytical Valve Box, such as VB1, VB3, or VB5. See section 4.3.11 to see how to change the mode of serial communication.

3.3.2.4 PROFIBUS PORT

There is a port for Profibus communication. The address is set in the in the System menu through the front panel touchscreen. The master Profibus PLC needs a GSD file to connect to the 3000RS-TXL. Request the GSD file from customer service at TAI.

Use only commercially available Profibus connectors. Do not build your own. It is recommended to use a straight out Profibus connector such as Siemens 6GK15000FC10 due to size and accessibility restrictions.

3.4 Installing the Micro-Fuel Cell

The Micro-Fuel Cell is not installed in the cell block when the instrument is shipped. Install it before the analyzer is placed in service. Refer to the procedure described in Section 5.2 for more information.

Once it is expended, or if the cell is exposed to air for too long, the Micro-Fuel Cell will need to be replaced. The cell could also require replacement if the instrument has been idle for too long.

When the Micro-Fuel Cell needs to be installed or replaced, follow the procedures in Chapter 5, *Maintenance*, for removing and installing cells.

3.5 Testing the System

Before plugging the instrument into the power source:

- Check the integrity and accuracy of the gas connections. Make sure there are no leaks.
- Check the integrity and accuracy of the electrical connections. Make sure there are no exposed conductors.
- Verify that the restriction device has been properly installed (see section 3.3.1).
- Check that inlet sample pressure is within the accepted range (see section 3.3.1).
- Power up the system and test it by repeating the Self-Diagnostic Test as described in Chapter 4, Section 4.3.5.

4 Operation

4.1 Introduction

Once the analyzer has been installed, it can be configured for your application. To do this you will:

- Set system parameters:
 - Establish a security password, if desired, requiring Operator to log in.
 - Establish and start an automatic calibration cycle, if desired.
- Calibrate the instrument.
- Define the three user selectable analysis ranges. Then choose auto ranging or select a fixed range of analysis, as required.
- Set alarm setpoints, and modes of alarm operation (latching, failsafe, etc).

Before you configure your 3000RS-TXL these default values are in effect:

Ranges: LO = 100 ppm, MED = 1000 ppm, HI = 10,000 ppm.

Auto Ranging: ON

Alarm Relays: Defeated, 1000 ppm, HI, Not failsafe, Not latching.

Zero: Auto, every 0 days at 0 hours.

Span: Auto, at 000008.00 ppm, every 0 days at 0 hours.

If you choose not to use password protection, the default password is automatically displayed on the password screen when you start up, and you simply press OK for access to all functions of the analyzer. See Section 4.5.1.

4.2 Start Up Screens

The Model 3000RS-TXL has a built-in self-diagnostic testing routine. Pre-programmed signals are sent through the power supply,

output board and sensor circuit. The return signal is analyzed, and at the end of the test the status of each function is displayed on the screen, either as OK or as a number between 1 and 3. (See *System Self Diagnostic Test* in Chapter 5, Section 5.4 for number code).

The self-diagnostics are run automatically by the analyzer whenever the instrument is turned on, but the test can also be run by the operator at will.

The first screen identifies the make and model of analyzer and has three touch sensitive buttons along the bottom.

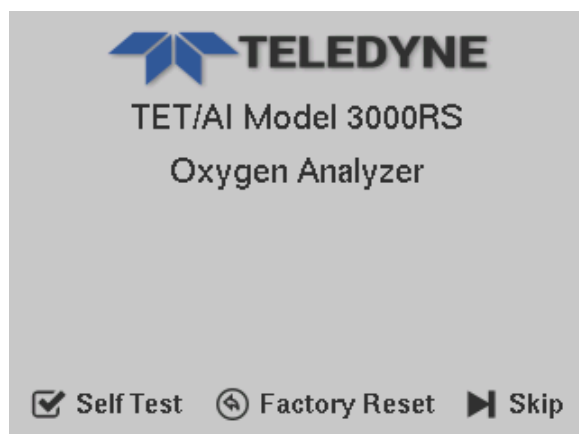

The buttons are:

1. Self-Test - Used to start the Self-Test diagnostic routine.
2. Factory Reset - Used to start a routine which will reset all the instrument's settings back to the factory default values.
3. Skip - Used to display the Main screen without performing the self-test.

If no key is pressed for 10 seconds, the system will automatically invoke the self-test and present the Diagnostics screen.

4.2.1 Diagnostic Screen

Clicking on Self-Test (or not pressing any other button for 10 seconds) will start the internal diagnostic self-test routine. It will update the status [PASS/FAIL] on this screen as it proceeds. The Self-Test routine includes the following processes.

- - Power supply section testing.

- - Analog output section testing.
- - Pre-amp testing.

As testing completes and results are reported, the list will extend beyond the bottom screen limit and a scroll bar will appear on the right. Use the scroll bar to view the additional test results.

Screen 1:

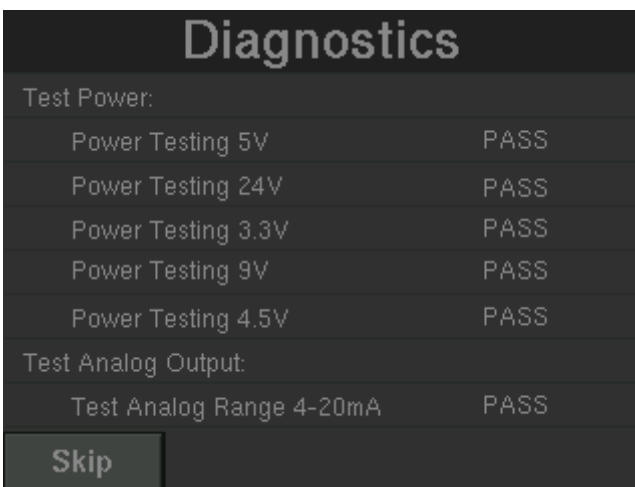

Using the scroll bar you can view all the test results.

Screen 2:

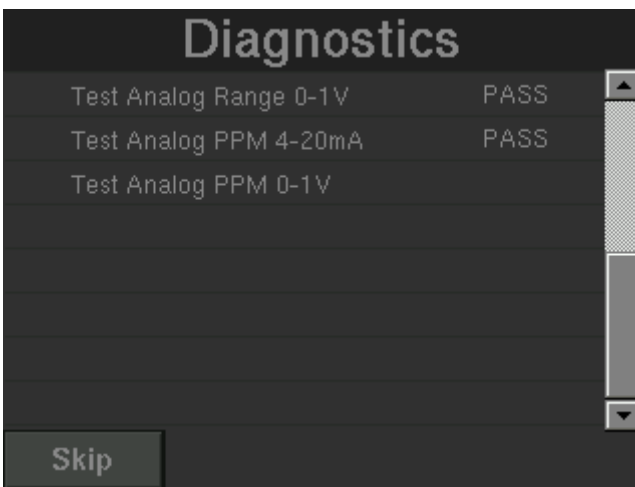

It is possible to skip the self-test at any time by pressing Skip button. .

1. SKIP - Skip the Test and move to the Main Screen.
2. Once self-test has completed, the display remains on the last screen awaiting any additional user input. If no button is pressed for 30 seconds, the system will automatically display the Main screen.

4.2.2 Factory Reset Screen

If the Factory Reset Button is pressed on the Start Up screen, the system will display the Factory Reset Screen. The System will calculate the electronic offset and all the user-settable configuration parameters will be reset to the factory default value. The Electronics Offset calculation screen will display as follows:

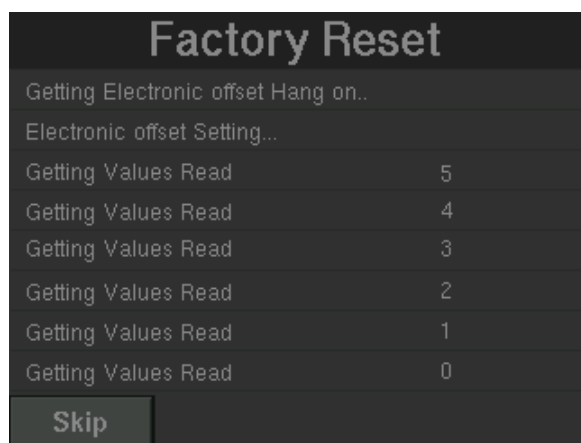

The Skip button at the bottom is used to skip the electronics test and proceed to the self-test. If the electronics offset is only partially complete when Skip is pressed, the system will reuse the last calculated electronics offset values.

1. SKIP - Display will move to the Main screen.
2. Once the electronics test has completed, the display remains on the last screen awaiting any additional user input. If no button is pressed for 10 seconds, the system will move to the Self-Test screen.

4.3 Main Screen

The screen display and available buttons depend on the particular function or screen selected for display. Figure 4-1 shows the default (Analyze mode) Main screen from which all other screens and menus can be summoned.

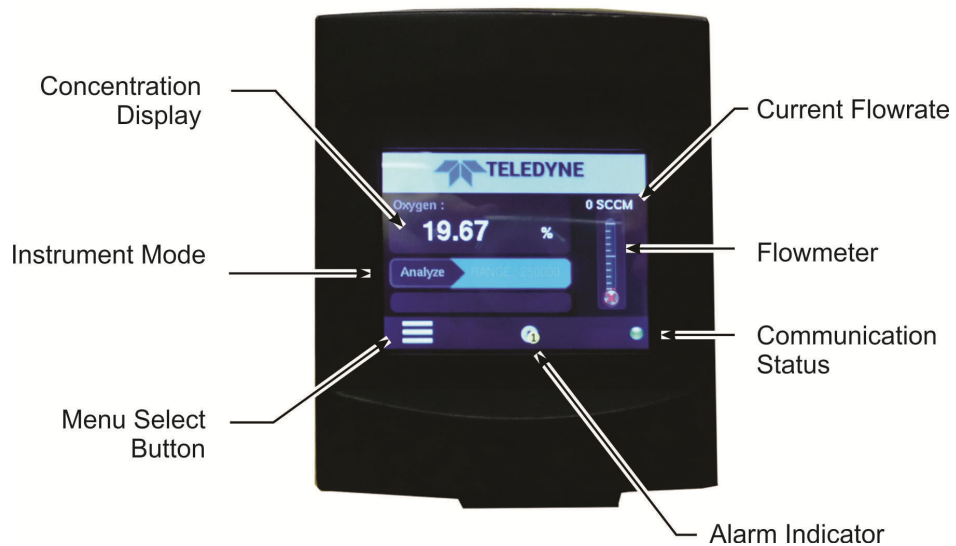

Figure 4-1: Analyze Screen Display

The bar at the bottom of the screen includes a menu select button, an alarm indicator, and an icon indicating current communication status. This bar will change in appearance depending on the selected function or system notification.

Two types of notification bars are used in 3000RS user interface (UI) screens:

- A. **Main Menu:** This is the notification bar with the menu select button displayed:



- B. **All other screens:** All other screens except Diagnostic and Factory reset screens have the Back button available to revert to the previous screen.



The notification bar has 2 navigate buttons and 3 status icons.

Navigation Buttons:

- 1. Home Icon: This touch sensitive icon is used to move to the Main screen from any other screen. The Home button will not appear in the Main screen and Menu screen.



- 2. Menu Icon: click on to navigate to the Menu Screen from the main screen.



Status icons:

- 1. LAN status Icon: displays when the LAN connection established.



- 2. Profibus Status Icon: Displays when the Profibus is connected.



- 3. Alarm:
 - i. No alarms : No Icon.
 - ii. Alarm 1 active:



iii. Alarm 2 active:



4.4 Menu Screen

Pressing the Menu icon from the Main screen produces the Menu Select Screen (Menu Select).

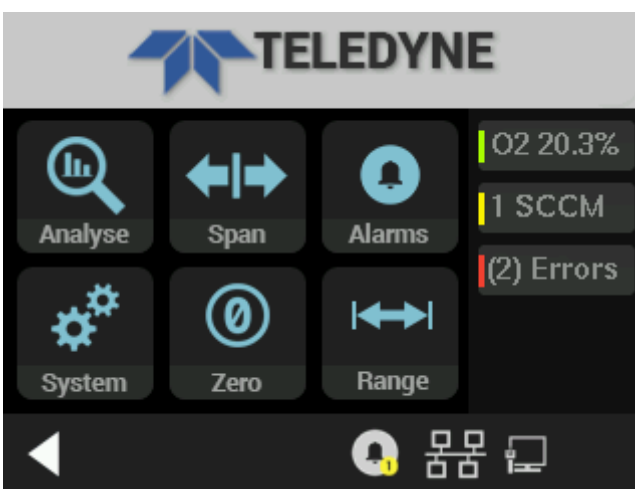

This screen has the “Back” arrow icon to navigate back to the Main screen.

The Menu screen has 6 selection buttons which are,

1. Analyse - Change system to Analyze mode.
2. Span - Start Span calibration.
3. Alarms - Move to Alarm configuration.
4. System - Move to System configuration.
5. Zero - Start Zero calibration.
6. Range - Range configuration

Three text boxes are used to display the oxygen concentration, flow rate and number of errors. These are synchronized with the main screen.

4.5 System Screen

Clicking on the System button on the Menu screen will cause the System screen to display.

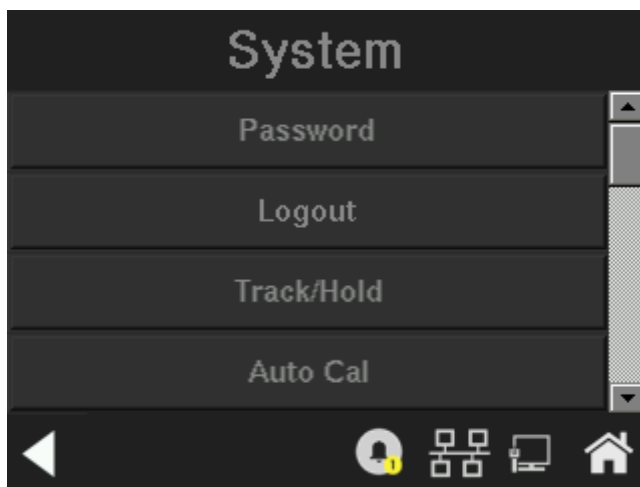

The System screen contains 13 functions with 4 options displayed per screen. Use the scroll bar on the right to view the various system functions.

The System screen provides the following functions:

1. Screen 1:
Password, Logout, Track/hold, Auto Cal
2. Screen 2:
Self-test, Flow limit, VB baud rate, Profibus
3. Screen 3:
Analog output, More, Version, System status
4. Screen 4:
Firmware Upgrade

Dragging on Scroll bar shows next 4 options. Click on any one of the options to navigate to that function screen.

Any function can be selected at any time by navigating to the proper System screen and pressing the appropriate onscreen button (unless password restrictions apply). The order as presented in this manual is appropriate for an initial setup.

Each of these functions is described in greater detail in the following procedures. The display screen text that accompanies each operation is reproduced, at the appropriate point in the procedure.

4.5.1 Password

The Password setup function is available from the first System screen.

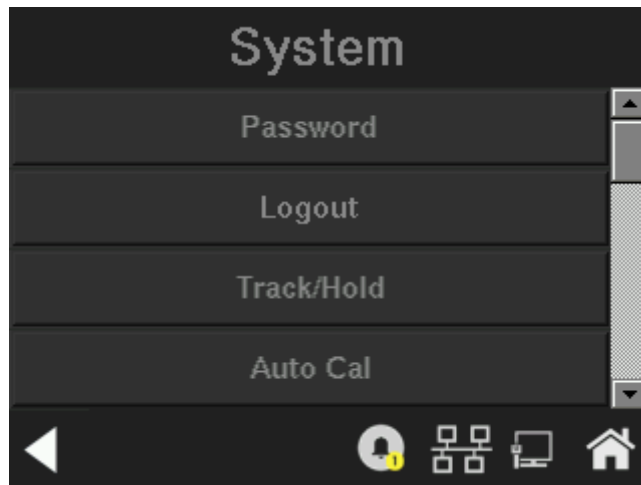

Selecting the password option from the first System screen produces the following display:

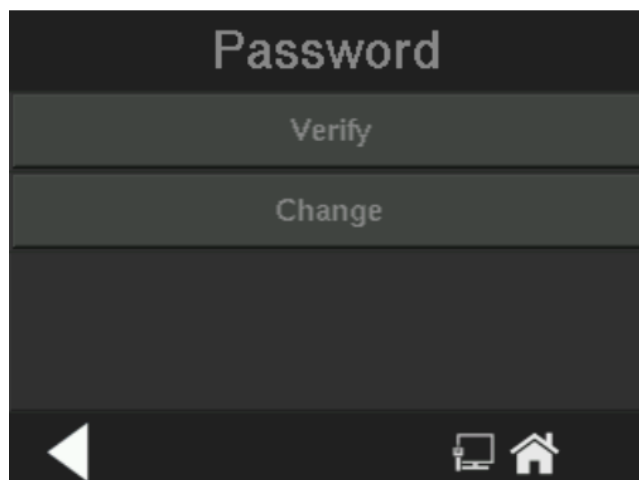

From this screen the user can select either to verify the existing password to gain access to the features of the instrument or to change

the existing password. **By default, the factory password - “TETAI” - will be used and all features will be available to the user.**

Verify: It prompts the user to enter the password to remove the password restrictions imposed on the different features in the instrument.

Change: This option can be used to change the existing password of the instrument. When the user presses the change option, the screen will change to Enter Password screen. Here the user must verify the existing password to get access to change the password.

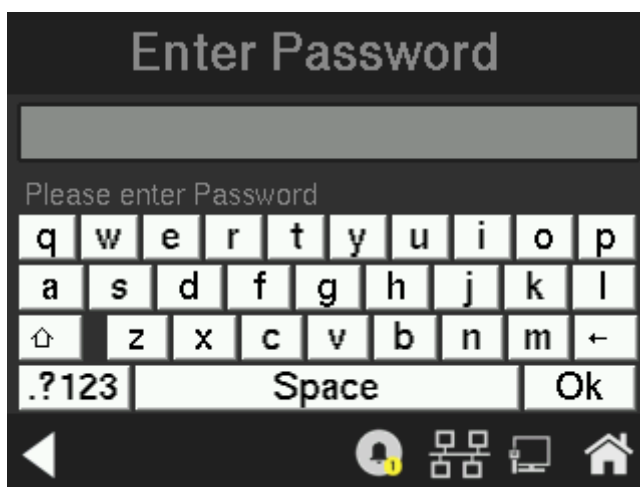

The following buttons are used to change the keypad mode.

 : special character button (only displays when needed)

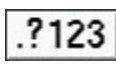
 : Number display setting button.

 : upper case letters display button.

 : lower case letters display button.

Pressing any of the above icons will display the type and format of the characters available:

Qwerty pad: Lower case letters (select  if another format button is currently enacted):

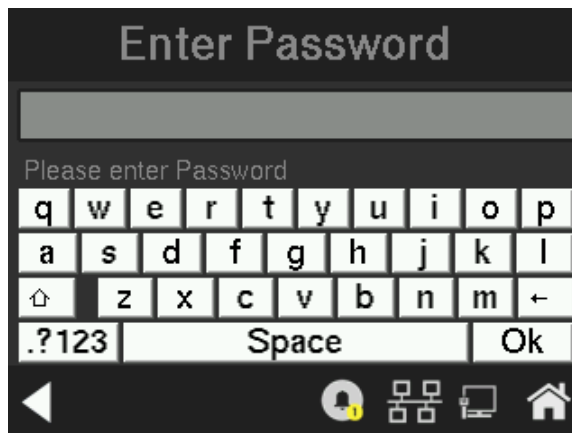

Qwerty pad: Upper case letters: (Select  if another format button is currently enacted):

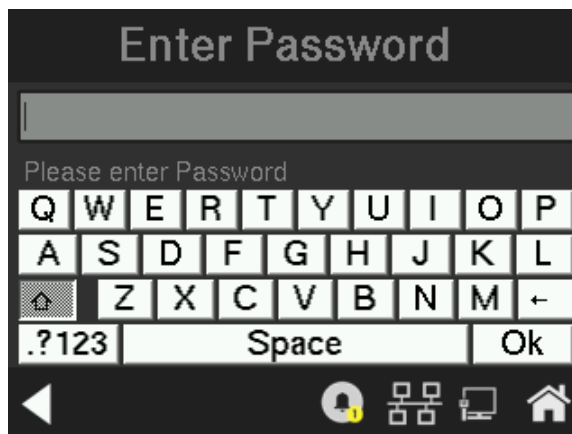

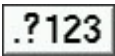
Number pad: (select )



Special character pad: (select )



Note: Factory default password is: TETA1 (capital letters).

4.5.2 Logout

The Logout function is available from the first System screen.

The Logout function provides a convenient means of leaving the analyzer in a password protected mode without having to shut the instrument off. By entering Logout, you effectively log off the instrument leaving the system protected against use until the password is reentered. To log out, press the *System* button from the Menu screen and then press Logout.

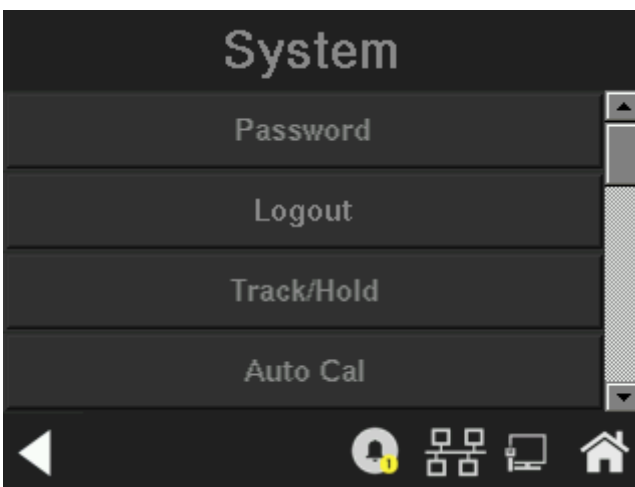

4.5.3 Track/Hold Screen

The Track/Hold function is typically used to keep the analog output from tracking a sample during a calibration. Establishing a HOLD on the output signal avoids producing unnecessary alarms when the span or zero gas is introduced into the analyzer during calibration.

When TRACK is selected, the analog outputs (0-1 VDC and 4-20 mA) and the range ID contacts will track the instrument readings during calibration (either zero or span). TRACK is the factory default.

When HOLD is selected, the analog outputs (0-1 VDC and 4-20 mA) and the range ID contacts will freeze on their last state before entering one of the calibration modes. When the instrument returns to the Analyze mode, either by a successful or an aborted calibration, there will be a three-minute delay before the analog outputs and the range ID contacts start tracking again.

Note that the concentration alarms freeze in their last state before entering calibration regardless of whether HOLD or TRACK is selected. But, when HOLD is selected, the concentration alarms will remain frozen for the time displayed in the second line of the TRAK/HLD menu after the analyzer returns to the Analyze mode.

The factory default is three minutes, but the delay time is programmable.

The TRACK/HOLD function is available from the first System menu screen. To enter the TRACK/HOLD function press System and then Track/Hold. The following screen will appear:

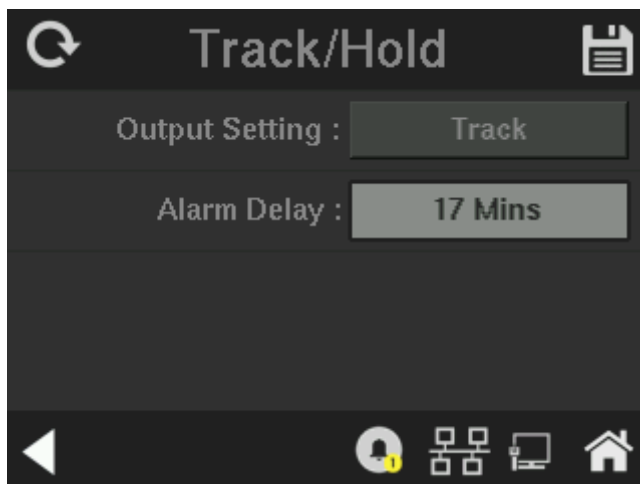

The Track/Hold screen has Output and Alarm delay settings.

The Output Settings can be toggled between “ Track” and “Hold” by touching the entry box.

The Alarm Delay is an Edit box with a numerical pad for entering the Alarm Delay.

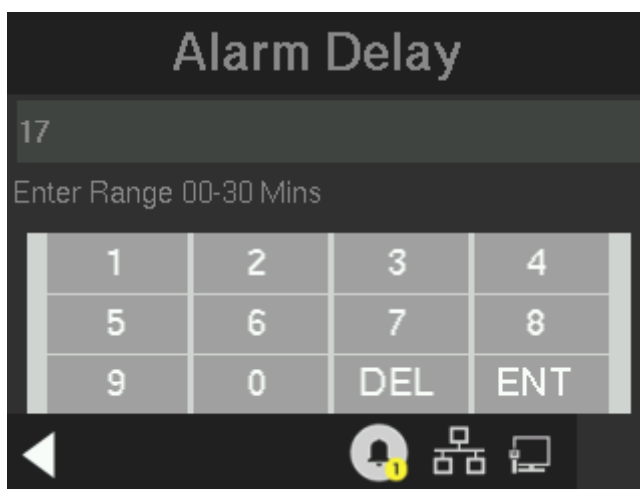

To adjust to delay time use the numerical pad to enter the value (in minutes). The minimum delay is 1 minute, the maximum is 30. This value is stored in non-volatile memory so that it is recovered if power is removed from the instrument.

The DEL button is used to delete a single character from the edit box. The ENT button is used to store the values and then move back to the parent (Track/Hold) screen. The back arrow on this screen will also move back to the parent Track /Hold screen but without saving edited values.

The Track/Hold screen also has Reset, Save and Back buttons.

Clicking on the Reset button  will revert to the previous values, and any changes that have been entered will not be saved.

Clicking on the Save button  will save the newly entered values.

Clicking on home button  will move to Main screen without saving edited values.

Clicking on the back button  will move the display back to the System screen. If any changes have been made, a message box will appear asking: “Do you want to save the changes?” Answer with Yes or No buttons to dismiss the screen.

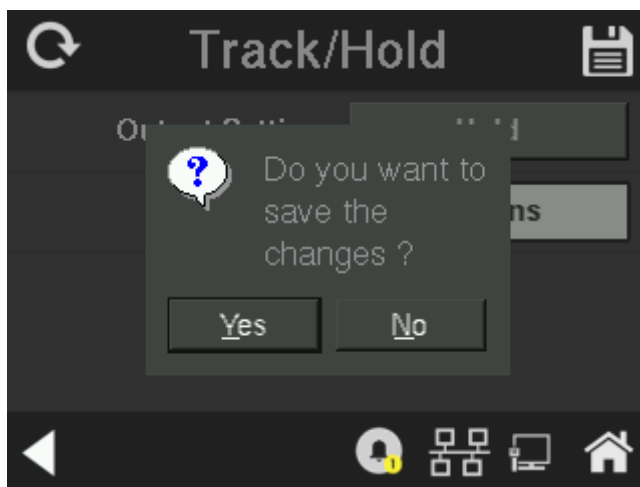

Clicking on “Yes” will save the entered values and move to the System screen. Clicking on “No” will discard the changes and move to System screen.

4.5.4 Auto Cal Screen

When proper automatic valving is connected (see Chapter 3, *Installation*), the analyzer can cycle itself through a sequence of steps that automatically zero and span the instrument. The Auto-Cal screens that follow can be used to define an automatic calibration sequence and/or start an Auto-Cal event.

The Auto Cal function is available from the first System screen.

To enter the Auto-Cal function press System and then Auto-Cal. A series of screens will appear beginning with the following screen:

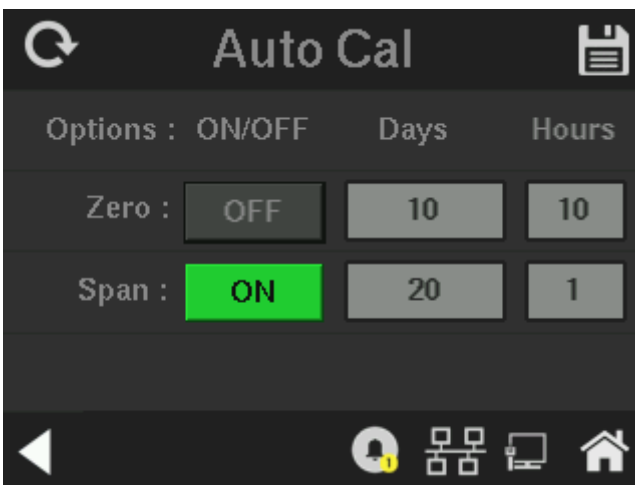

Auto Cal screen has the following options,

- A. Auto Cal Zero ON or OFF
- B. Auto Cal Span ON or OFF

The Zero/Span schedule can be set to xxx days and xx hours before the next auto calibration cycle will automatically occur. The Zero and Span rows have Days and Hours Edit boxes. Clicking on the edit box will bring up individual number pads for entering or editing the Days and Hours setting.

The Zero Days / Span Days range from 1 to 999 .

Zero Days:

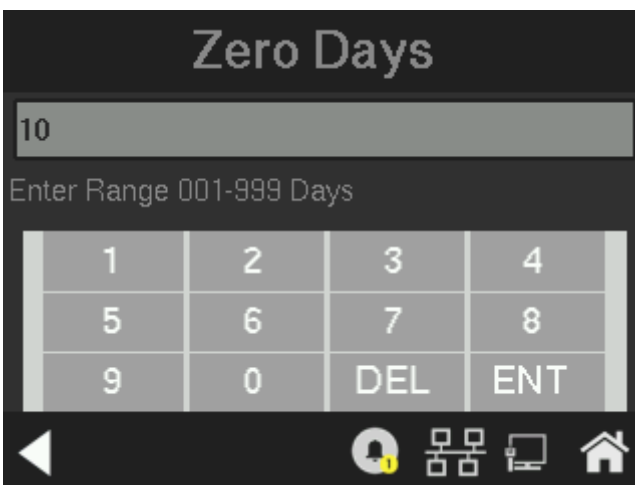

Span Days:

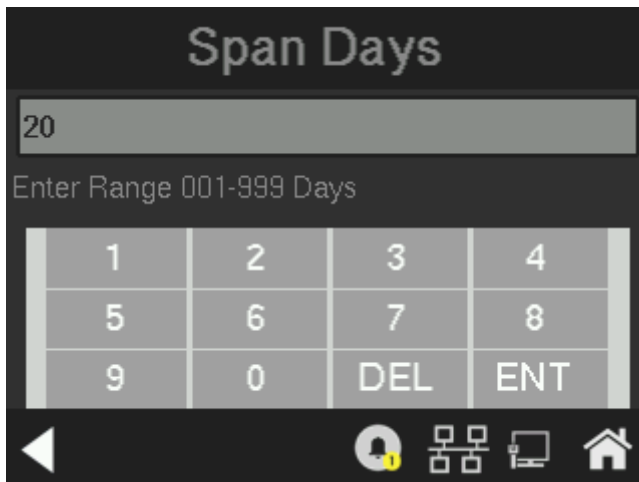

Clicking on the DEL button will delete one character with each click from the Edit box. Clicking on the ENT button will store the entered values and move back to the parent (Auto Cal) screen. Clicking on the back arrow will move to the Auto Cal screen as well but without saving the edited values.

Zero Hours

The range of Zero/Span Hours is from 0 to 23

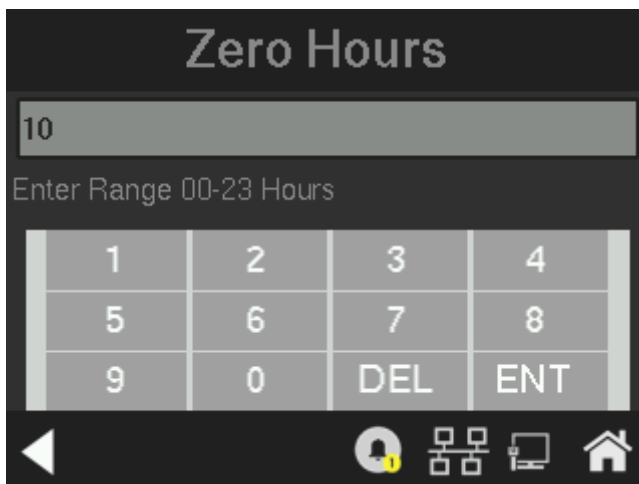

Span Hours

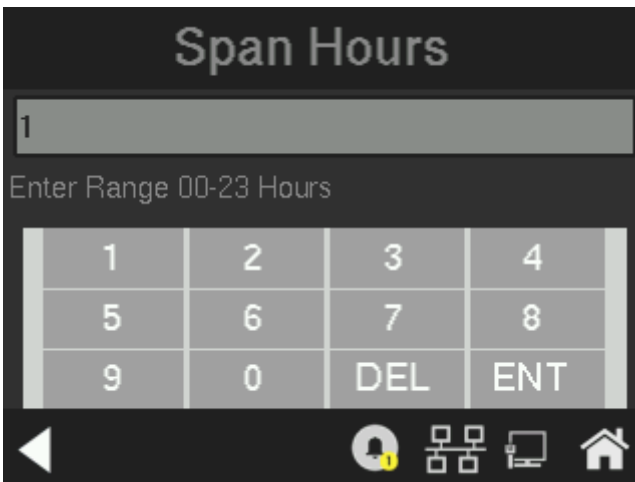

Clicking on the DEL button will delete one character with each click from the Edit box. Clicking on the ENT button will store the entered values and move back to the parent (Auto-Cal) screen. Clicking on the back arrow will move to the Auto Cal screen as well but without saving the edited values.

Auto Cal screen has Reset, Save and Back buttons.

Clicking on the Reset button  will revert to the previous values and any changes that have been made will not be saved.

Clicking on home button  will move to main screen without saving the edited values.

Clicking on the Save button  will save the newly entered values.

- A. If both Zero and Span calibration have been set “ON” and SAVE is pressed, the following pop-up message will appear:

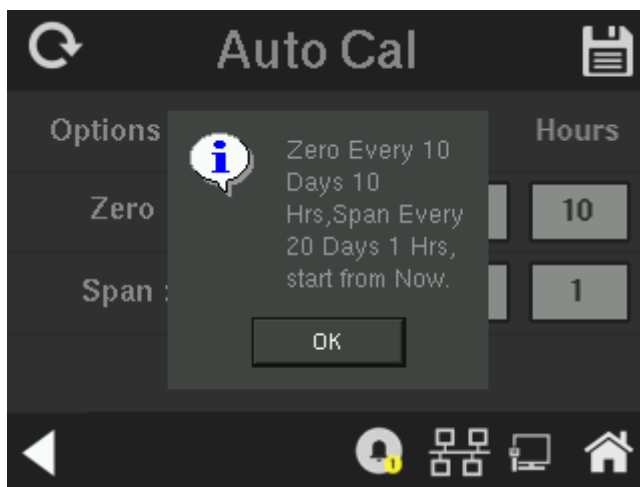

- B. If only the Zero calibration has been set to “ON” and the SAVE button is pressed, then the following pop-up message will appear:

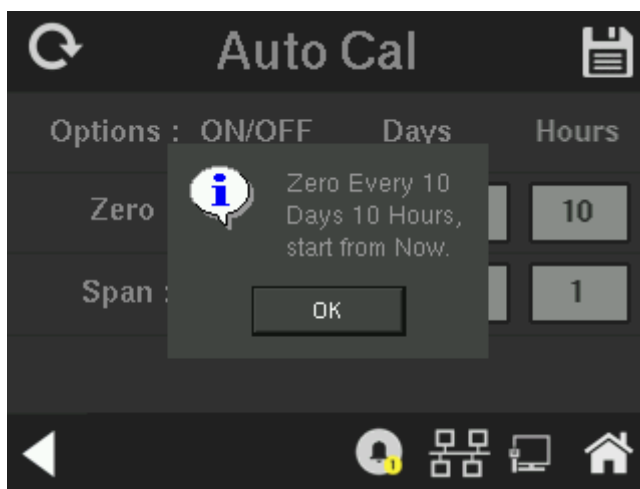

- C. If only the span calibration is set to “ON” and the SAVE button is pressed, the following pop-up message will appear:

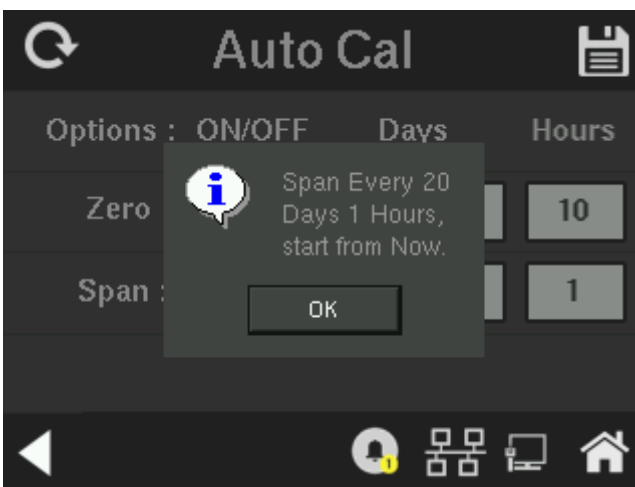

- D. If both zero and span calibration are set to “OFF” then no pop-up messages will be displayed.
- E. Clicking on the back button  will move the display back to the System screen. If any changes have been made, then a message box will be shown asking: “Do you want to Save the changes”. Use the Yes or No buttons to answer and dismiss the screen.

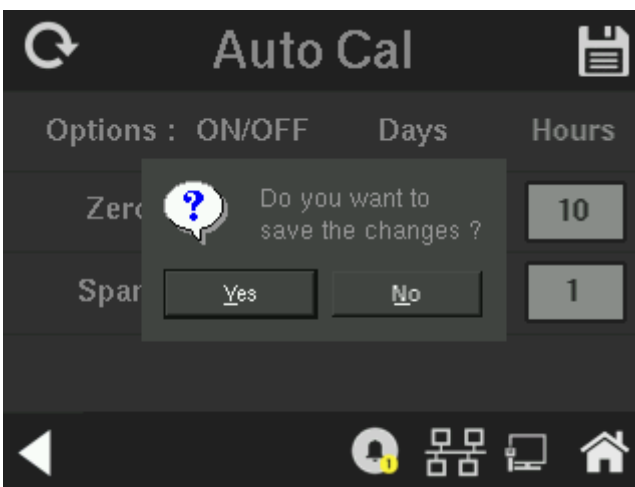

- Clicking on “Yes” will save user entered values and move to the System screen.
- Clicking on “No” will discard the changes and move to System screen.

4.5.5 Self-Test

The analyzer undergoes a diagnostic self-testing routine whenever it is powered on. In addition, this routine can be summoned at any time using the Self-Test function. This function is found on the second System screen. Use the scroll bar on the System screen to move to the second screen.

System screen 2:

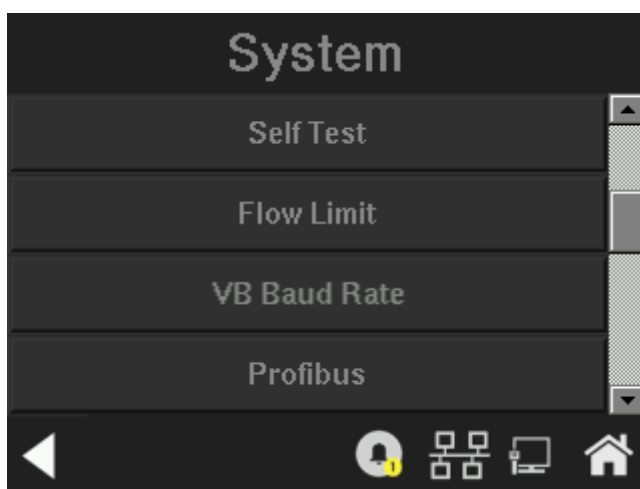

Pressing Self-Test will initiate the self-test routine as described in Section 4.2.

4.5.6 Flow Limit

The Flow Limit function allows the user to set or edit the limit on the gas flow through the analyzer. It also indicates the flow status, whether the flow alarm is ON or OFF, and the current flow rate.

The Flow Limit function is available from the second System screen. To enter this function, press System and scroll to the second screen.

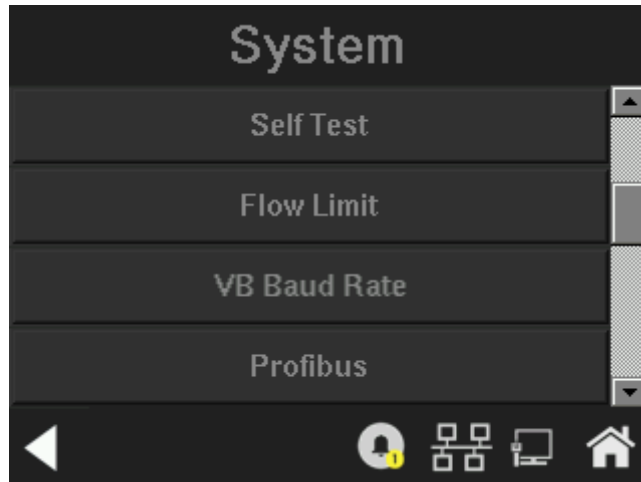
System screen 2:

Press Flow Limit to enter the function. The following screen will appear:

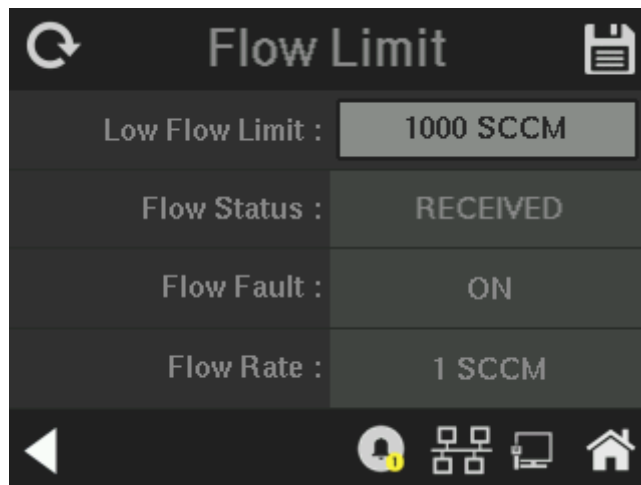
Flow Limit:

The Flow Limit screen has the following options:



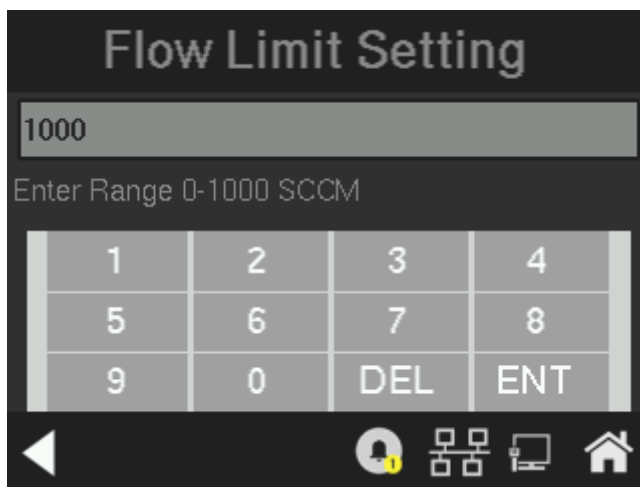

1. Option to enter or edit the Low Flow limit. This is an editable field.
2. Current Flow Status, Flow Fault status, and Flow rate. These three parameters are non-editable.

Clicking on the Low Flow Limit Edit box will bring up a number pad for editing the displayed value.



1. Enter the flow setting from 0 to 1000 SCCM.
2. Use the “DEL” button to delete a single character at a time from the Edit box.
3. Use the “ENT” Button to store the value and move back to the parent (Flow Limit) screen.
4. The “back arrow” button will cause the display to move back to the Flow Limit screen without saving the edited values.

The Flow Limit screen has Reset, Save and Back buttons.

1. Clicking on the Reset button  will revert to the old values, if in case any changes have been entered.
2. Clicking on the Save button  will save the newly entered values.
3. Clicking on home button  will move the display to the Main screen without saving the edited values.
4. Clicking on the back button  will move the display back to the System screen. If any changes have been entered, a message box will appear requesting: “Do you want to Save the changes?” Use the Yes or No buttons to reply.

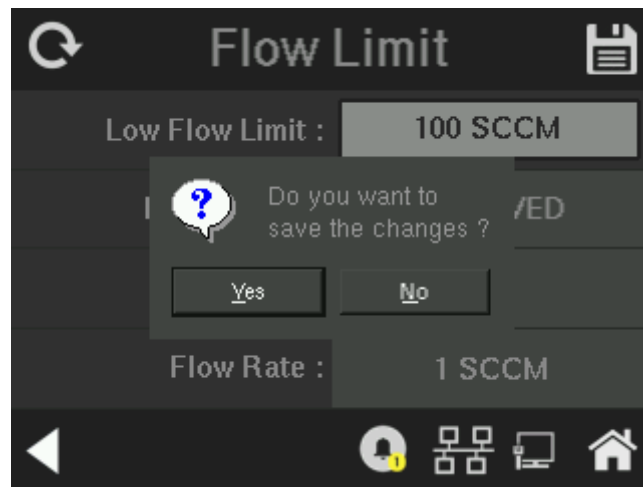

- “Yes” will save user entered values and move to the System screen.
- “No” will discard the changes and move to System screen.

4.5.7 VB Baud Rate Screen

The VB Baud Rate screen allows the user to set or edit the baud rate, Data bits, Parity type and includes dropdown selectable options.

The VB Baud Rate function is available from the second System screen. To enter this function, press System and scroll to the second screen.

System screen 2:

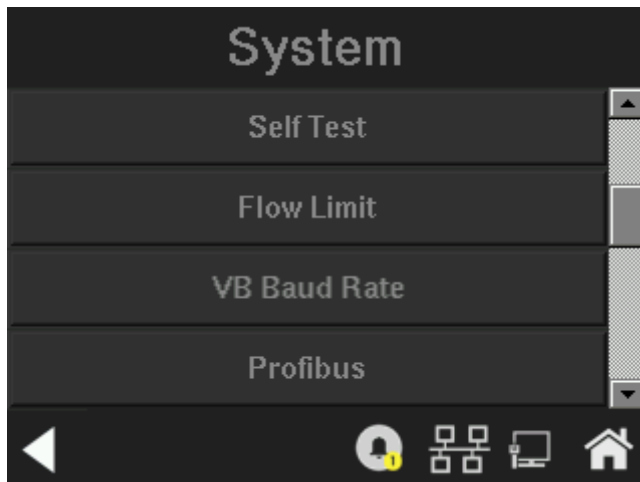

Select VB Baud Rate to enter display the VB Baud rate setup screen.

VB Baud Rate setup screen:

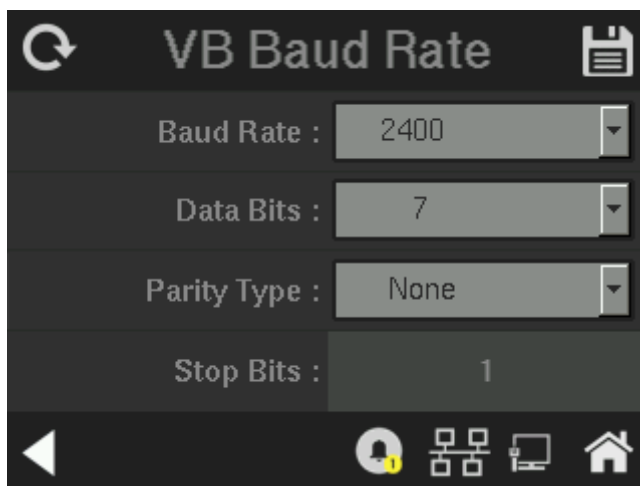

The Baud Rate Baud display box includes a drop-down selection of the available rates. Use the scroll bar to view all entries. Select either 2400, 4800, 9600, 19200, 38400, or 115200 bits per second.

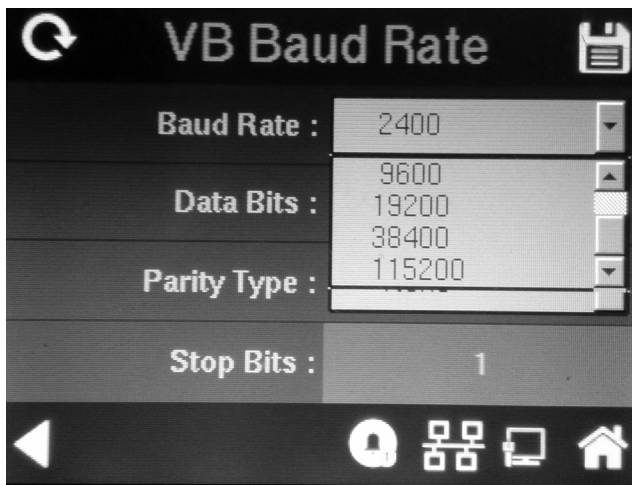

Similarly with the Data Bits entry box, the drop-down menu shows the available selections. Select either 7, 8 or 9 data bits.

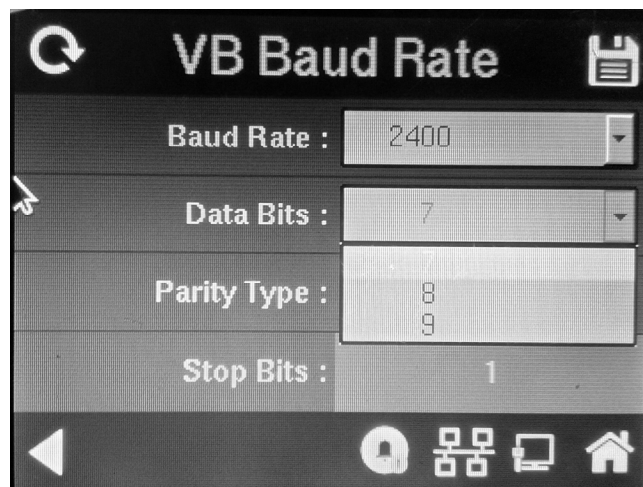

From the Parity entry box, the user can select None, Even or Odd parity.

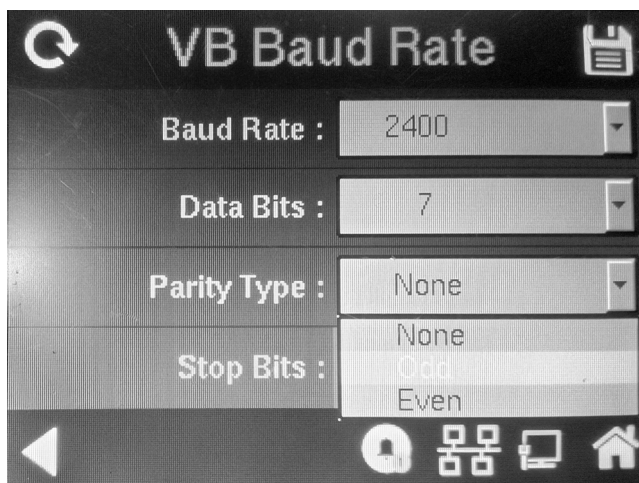

The Stop Bits box is an information only box. It will be always 1 and is not editable.

4.5.8 Profibus Screen

When using Profibus communication, the Profibus function available from System screen 2 displays the Profibus configuration.

System screen 2:

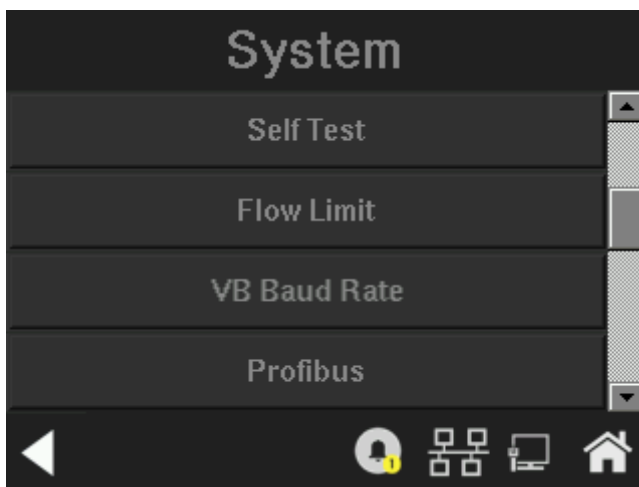

4.5.8.1 PROFIBUS ADDRESS

Press Profibus to display the Profibus configuration screen.

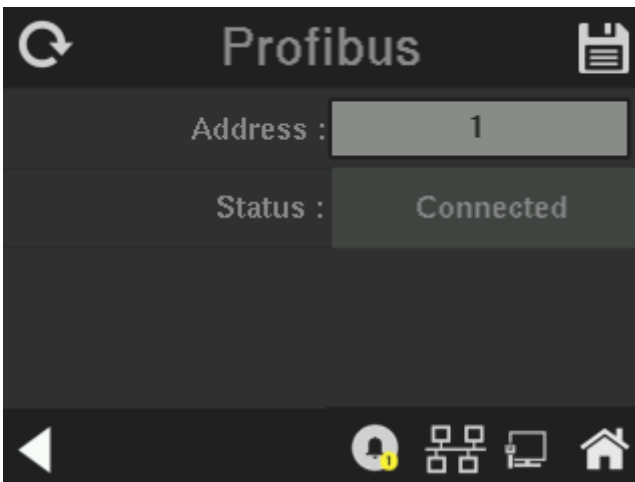
Profibus screen:

From this screen, the user can view and edit the Profibus slave address as well as see the current status (connected or disconnected).



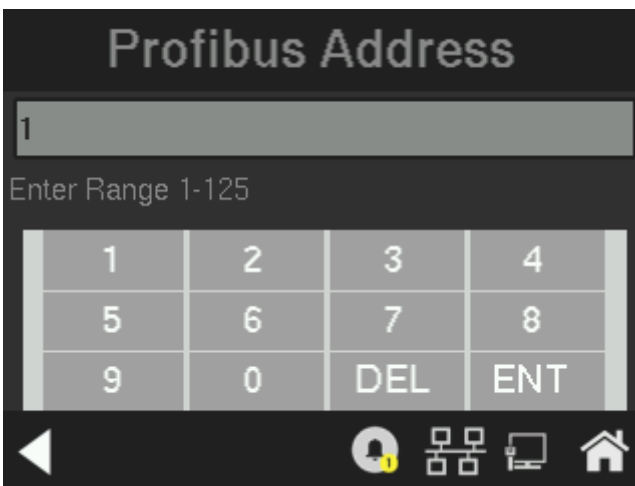

Selecting Address by pressing on the edit box brings up a numerical pad for entering or editing the slave address.



1. The Profibus address can range from 1 to 125.
2. Click on the "DEL" button to delete the one character at a time from the Edit box.
3. Click on "ENT" Button to store the values and move back to the parent (Profibus) screen.

4. Click on “back arrow” button on this screen, to move back to the Profibus screen without saving the edited value.

The Profibus screen has Reset, Save, and Back buttons.

1. Clicking on the Reset button  will revert to the old values, and any changes that have been made will not be saved.
2. Clicking on the Save button  will save the newly entered values.
3. Clicking on home button  will move the display to the Main screen without saving the edited values.
4. Clicking on the back button  will move the display back to the System screen. If any changes have been entered, a message box will appear requesting: “Do you want to Save the changes?” Use the Yes or No buttons to reply.

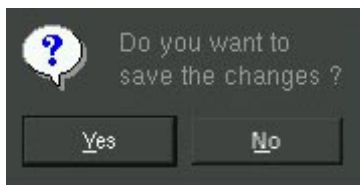

- “Yes” will save user entered values and move to the System screen.
- “No” will discard the changes and move to System screen.

4.5.8.2 PROFIBUS STATUS

The status of the Profibus connection can be viewed from this screen. The Status box will indicate:

- “Connected” if the 3000RS board is connected to the external PC software Profitrace.
- “No Connection” if the 3000RS board Profibus communication has failed to communicate the external with PC software Profitrace.

4.5.8.3 PROFIBUS TASK

The Profibus task will receive remote commands from a master PLC. These are the System module input registers:

Address	Byte Location	Variable	Variable description
0x00 - 0x03	0x00	Analyzer command	0x01 - Analyze 0x08 - Span 0x10 - Zero 0x20 - ESC
	0x01	Reserved	Reserved
	0x02	Flow Rate (LSB)	Flow Limit
	0x03	Flow Rate (MSB)	
0x04-0x07	0x04	Span Concentration	Span Concentration
	0x05		
	0x06		
	0x07		

The System output module registers are organized like this:

Group	Address	Bit Number	Variable	Variable description
Gas Concentration Value (0x00 - 0x03)	0x00		Gas concentration (LSB)	Current gas concentration values updated.
	0x01			
	0x02			
	0x03		Gas concentration (MSB)	
Reserved (0x04 - 0x07)	0x04 - 0x07		Reserved	Reserved
Model Number (0x08-0x0F)	0x08		Model No (LSB) - 0x08	System model no will be updated
	0x09-0x0E			
	0x0F		Model No (MSB) - 0x0F	

Group	Address	Bit Number	Variable	Variable description
Serial Number (0x10 - 0x17)	0x10		Serial No (LSB) - 0x10	System serial no will be updated
	0x11 - 0x16			
	0x17		Serial No (MSB) - 0x17	
Software Version (0x18)	0x18		Software Version	Software version will be updated(multiply by 10) update first two digits of software version. Example: 1.2.0, will be 1.2*10 = 12
Diagnostic status - Power on test results (0x19)	0x19	0	5V	Based on the diagnostic result, system will set the diagnostic variable bit as 1 or 0. 0 - PASS 1 - FAIL
		1	3.3 V	
		2	9V	
		3	24V	
		4	4..5V	
		5	Range 4 - 20 mA	
		6	Range 0 - 1 V	
		7	PPM 4 - 20 mA	
Diagnostic status - Power on test results (0x1A)	0x1A	0	PPM 0 - 1 V	
		1	PREAMPStatus	
		2-7	Reserved	
Diagnostic status - Reserved (0x1B)	0x1B		Reserved	Reserved
System Mode (0x1C)	0x1C	0	Analyzer Mode, Zero Mode	Current system mode will be updated in the 0th and 1st bit. The mode values will be 00 - Init (0)
		1	Span Mode, Zero Mode	
		2	Reserved	

Group	Address	Bit Number	Variable	Variable description
		3	Reserved	01 - Analyzer mode (1) 10- Span mode (2) 11- Zero mode (3)
		4	Reserved	
		5	Reserved	
		6	Reserved	
		7	Reserved	
System Status - Negative Sign, Heart beat (0x1D)	0x1D	0	Negative sign bit	when the negativesign bit is enabled,system will set this bit as high. otherwise it be zero.
		1	Heart bit	System will toggle the bit at costant intervals
		2	Flow Fault Indication	When flow fault occurs, system will set the bit as HIGH (1).
		3	Alarm1	Based on alarm1 status 0 - OFF, 1 - ON
		4	Alarm2	Based on alarm2 status 0 - OFF, 1 - ON
		5-7	Reserved	Reserved
		System Status - Communication and Calibration (0x1E)	0x1E	
System Status - Reserved (0x1F)	0x1F		Reserved	Reserved

Group	Address	Bit Number	Variable	Variable description
Current Flow Rate (0x20 - 0x21)	0x20		Flow rate (LSB)	System will update current flow rate.
	0x21		Flow rate (MSB)	
Reserved (0x022 - 0x23)	0x22		Reserved	Reserved
	0x23		Reserved	Reserved

The value of flow of and flow limits is given through two bytes, and LSB and a MSB. Both together can be converted to an integer value. That value is the flow in CCM.

The span value and the gas value are given in four bytes, those four bytes are combined into a 32-bit word to be converted into a float value. The float value is O2 concentration in ppm.

4.5.9 Analog Output

The analog output signal from the Model 3000RS is a voltage (0-1 VDC) or current (4-20 mA) signal which depends on the oxygen concentration AND the currently activated analysis range. To relate the signal output to the actual concentration, it is necessary to know what range the instrument is currently on, especially when the analyzer is in the auto ranging mode.

The Analog Output screen allows the user to choose the output configuration for the range ID and the concentration. The available choices are 0-1 VDC or 4-20 mA. **Note that both outputs are not available at the same time.**

The Analog Output function is available from the third System screen. To enter this function, press System and scroll to the third System screen.

System screen 3:

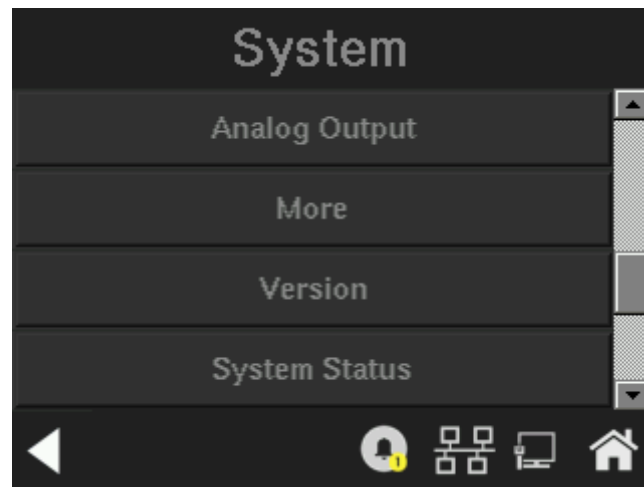

Press Analog Output to display the following screen:

Analog Output screen:

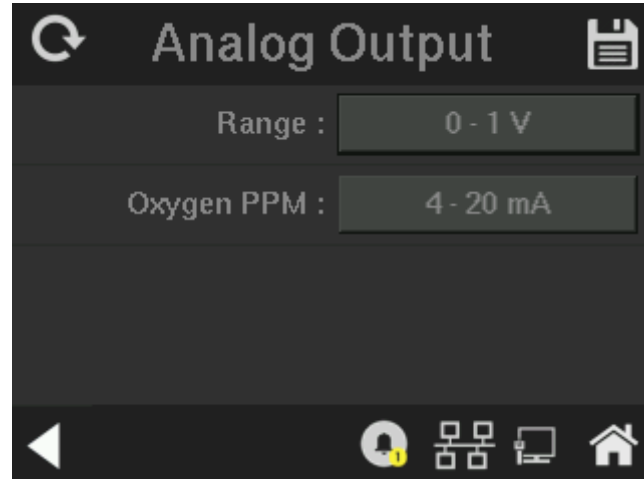

4-20 ma calibration:

If 4-20 ma output is chosen, there is a choice to calibrate the 4-20 ma analog outputs endpoints. The calibration buttons will appear.



A DVM set in milliampere measurement will need to be connected on the corresponding 4-20 ma output pins of the D-Sub 50 pin connector on the back panel. See table 3-1. Pressing the button will bring the 4 mA adjustment setting first.



To adjust the 4-20 mA, press the button with count button and adjust the count value with the numeric keypad to change the 4 mA setting. Press the ENT button for the new adjustment to take effect and check the DVM.

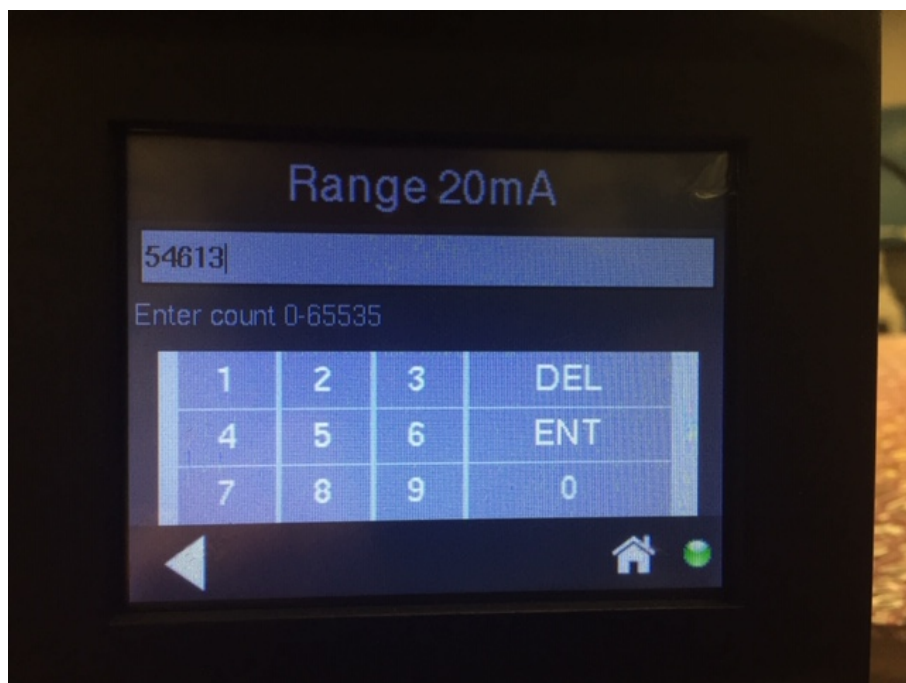

When the DVM reads 4.00 mAdc, press the “Save Calibration Value” button and now the 20 mAdc adjustment screen will appear. Repeat the adjustment till DVM reads 20.0 mAdc. Press “Save Calibration Value” button again to finish the 4-20 mA calibration.

4.5.9.1 RANGE IDENTIFICATION

Click on the edit box for Range to toggle between “0-1V” and “4-20mA”.

Selecting 0-1V or 4-20 mA for Range ID will scale the range identification as follows:

Range	Voltage	Current
LO	0.25	8
MED	0.50	12
HI	0.75	16
CAL (0-25%)	1.00	20





4.5.9.2 CONCENTRATION

The signal output for concentration is linear over the currently selected analysis range. For example, if the analyzer is set on range that was defined as 0–100 ppm O₂, then the output would be:

The signal output for concentration is linear over the currently selected analysis range. For example, if the analyzer is set on range that was defined as 0–100 ppm O₂, then the output would be:

ppm O ₂	Voltage Signal Output (VDC)	Current Signal Output (mA dc)
0	0.0	4.0
10	0.1	5.6
20	0.2	7.2
30	0.3	8.8
40	0.4	10.4
50	0.5	12.0
60	0.6	13.6
70	0.7	15.2
80	0.8	16.8
90	0.9	18.4
100	1.0	20.0

The Analog Output screen has Reset, Save, and Back buttons.

1. Clicking on the Reset button  will revert to the old values and any changes that have been made will not be saved.
2. Clicking on the Save button  will save the newly entered values.
3. Clicking on home button  will move the display to the Main screen without saving the edited values.
4. Clicking on the back button  will move the display back to the System screen. If any changes have been entered, a message box will appear requesting: “Do you want to Save the changes?” Use the Yes or No buttons to reply.

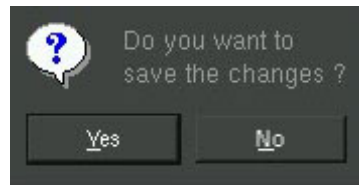

- “Yes” will save user entered values and move to the System screen.
- “No” will discard the changes and move to System screen.

4.5.10 More Screen

The More button contains a group of 4 additional system functions: Serial Number, Negative Number, Stream Selection and Model Number. It is available from the third System function.



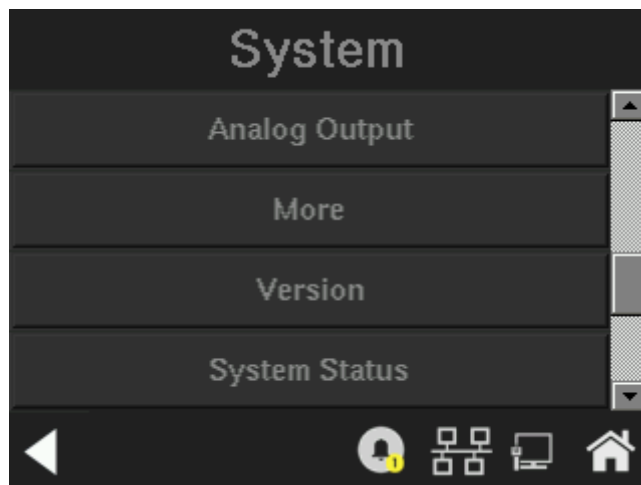

System screen 3:

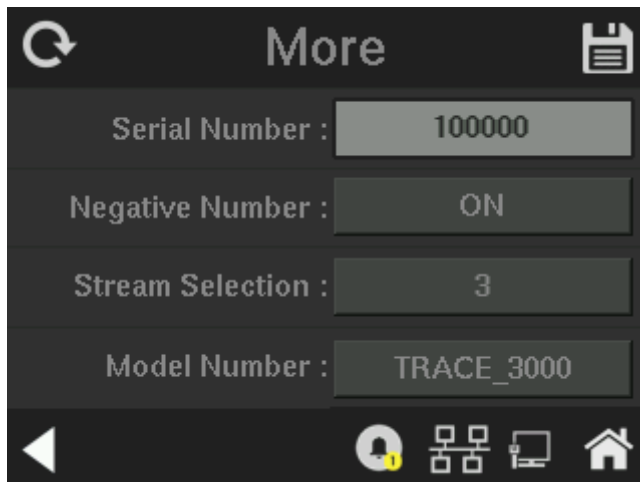

Press More to view the additional functions.

More screen:

The More screen has Reset, Save, and Back buttons.

1. Clicking on the Reset button  will revert back to the old values and any changes that have been made will not be saved.
2. Clicking on the Save button  will save the newly entered values.
3. Clicking on home button  will move the display to the Main screen without saving the edited values.
4. Clicking on the back button  will move the display back to the System screen. If any changes have been entered, a message box will appear requesting: “Do you want to Save the changes?” Use the Yes or No buttons to reply.

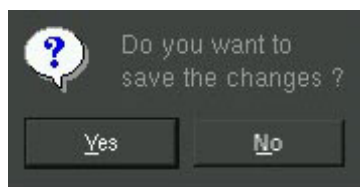

- “Yes” will save user entered values and move to the System screen.
- “No” will discard the changes and move to System screen.

4.5.10.1 SERIAL NUMBER

Serial Number is an Edit box used to enter a serial number range from 100000 to 999999. This is used in conjunction with a Teledyne Valve Box for remote valve actuation.

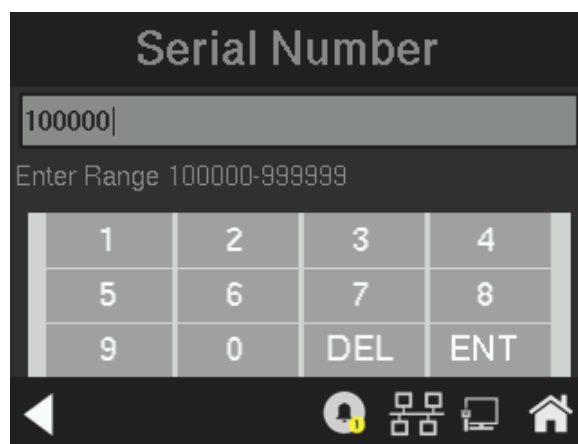

1. The Serial Number can range from 100000 to 999999.
2. Click on the “DEL” button to delete the one character at a time from the Edit box.
3. Click on “ENT” Button to store the values and move back to the parent (More) screen.
4. Click on the “back arrow” button on this screen to move back to the More screen without saving the edited value.

4.5.10.2 NEGATIVE NUMBER

The instrument can be reconfigured to show negative readings which would be useful if the sensor output has drifted below zero. This situation may arise after the instrument has been zeroed, as time progresses the sensor may drift below the zero calibration setpoint.

To show negative oxygen readings on the display, toggle the edit box from NO to YES.

1. Negative number- ON: The system will show negative values of slope or calculation result.

2. Negative number- OFF: The system will show 0.00 when negative values are obtained from a calculation result.

This preference is stored in non-volatile memory, so this configuration is remembered after a power shutdown. If the instrument is cold started, it will go back to default (not showing negative oxygen readings).

If Show Negative has been set to NO (default), then the display will remain at zero when the output from the sensor drifts below zero. The analog output signal will also remain at 4 mA if the sensor output is negative.

4.5.10.3 STREAM SELECTION

The Stream function is useful when the analyzer is connected with a TAI Valve Box. It allows the user to switch the input stream from the analyzer rather than the Valve Box. This assumes that the analyzer is in local mode and not being controlled by an external source. If the analyzer is not interfaced with a Valve Box, this function has no input.

The Stream Selection options are 1/2/3. The selected stream number will be sent to a Valve Box through the RS232 port.

4.5.10.4 MODEL NUMBER

This function allows the user to select between the options “TRACE_3000” or “PERCENT_3000” depending on the anticipated range of analysis. For trace analysis the system must be equipped with an appropriate trace analysis micro fuel cell.

4.5.11 Version

The Version screen is a read-only screen that displays the manufacturer, model, and software version information. It is accessible from the third System screen.

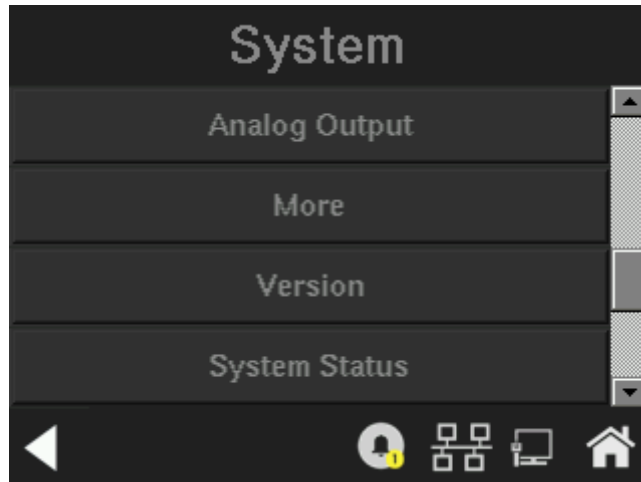
System screen 3:**Version screen:****4.5.12 System Status**

The System Status screen is available from the third System screen. It displays the current system status for the following features:

- A. LAN status: IP address, protocol mode, gateway address, supported protocols.
- B. USB status: Number of USB devices connected and details.
- C. SDCARD status and memory

- D. Profibus status: Slave address, input and output register types, number of input and output registers.
- E. Alarm relay status and solenoid valve status
- F. Remote zero/span status
- G. Analog output status (Range ID and concentration analog outputs)

Note: The System Status function is not implemented in this version.

4.5.13 Firmware Upgrade

The Firmware Upgrade function provides an option to upgrade the firmware on the motherboard. It is available from the fourth System screen.

Note: The Firmware Upgrade function is not implemented at this time.

System screen 4:

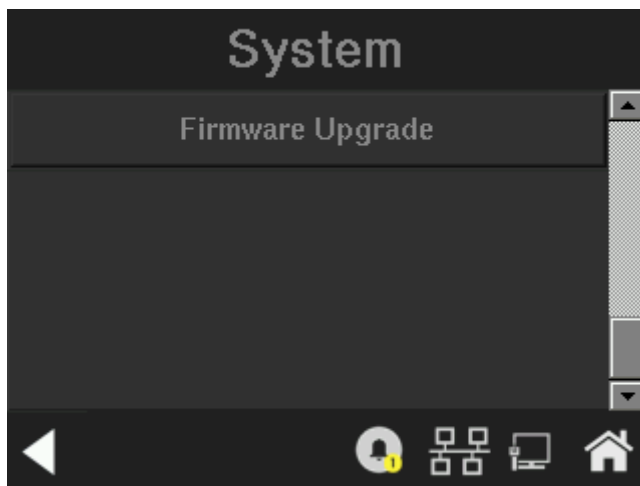

- A. When the motherboard firmware is passed through a LAN or SDCARD, the front panel board will copy the firmware file to an internal storage device and then display the motherboard firmware details to this screen.
- B. The user has the option to update the motherboard firmware now or later.

- C. This function will also provide an option to update the front panel UI firmware as well.
- D. The Firmware Upgrade function will display the firmware update date and time for both the front panel and motherboard.

4.6 The Range Function

The Range function allows the operator to program up to three concentration ranges to correlate with the DC analog outputs. If no ranges are defined by the user, the instrument defaults to:

Low = 0–1 ppm

Med = 0–10 ppm

High = 0–100 ppm

The Model 3000RS is set at the factory default to auto ranging. In this mode, the microprocessor automatically responds to concentration changes by switching ranges for optimum readout sensitivity. If the current range limits are exceeded, the instrument will automatically shift to the next higher range. If the concentration falls to below 85% of full scale of the next lower range, the instrument will switch to that range. A corresponding shift in the DC percent-of-range output, and in the range, ID outputs, will be noticed.

The auto ranging feature can be overridden so that analog output stays on a fixed range regardless of the oxygen concentration detected. If the concentration exceeds the upper limit of the range, the DC output will saturate at 1 VDC (20 mA at the current output).

However, the digital readout and the RS-232 output of the concentration are unaffected by the fixed range. They continue to read accurately with full precision. See *Front Panel* Description in Chapter 1.

The automatic air calibration range is always 0-25 % and is not programmable.

4.6.1 Setting the Analog Output Ranges

To set the ranges, enter the range function mode by pressing the *Range* button in the Menu screen.

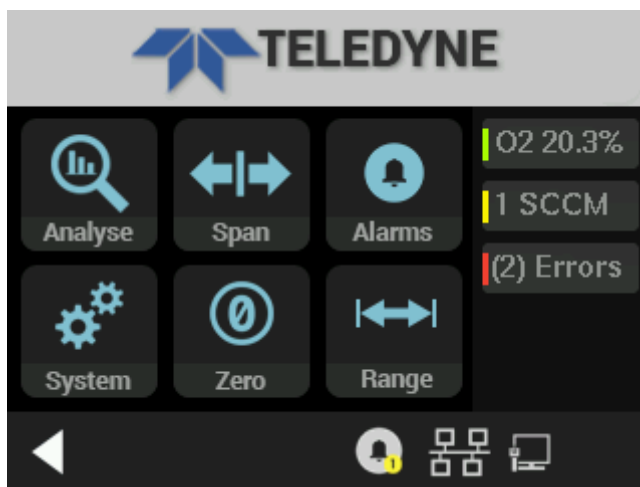

After pressing Range, the Range screen will appear.

Range screen:

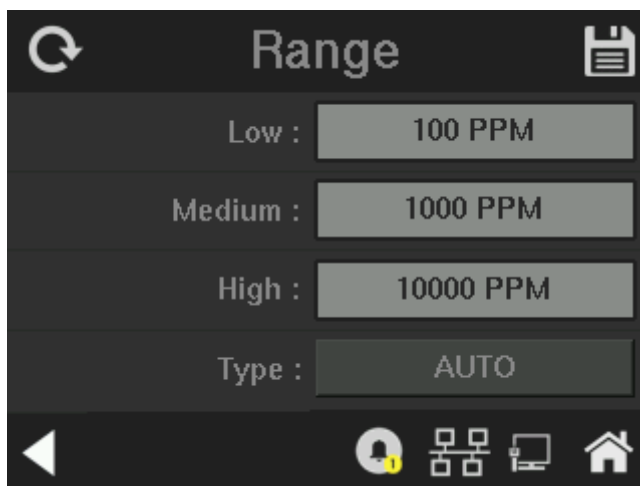

This screen includes options to edit the LOW, MEDIUM, and HIGH ranges (in ppm) as well as the Range Type (fixed range or auto range). All ranges begin at 0 ppm.

Note: The ranges must be increasing from low to high, for example, if range 1 is set as 0–100 ppm and range 2 is set as 0–1,000 ppm, range 3 cannot be set as 0– 500 ppm

since it is lower than range 2.

Ranges, alarms, and spans are always set in ppm units. All ranges extend from 0-250,000 ppm.

Press the edit box in the LOW range field to edit this range.

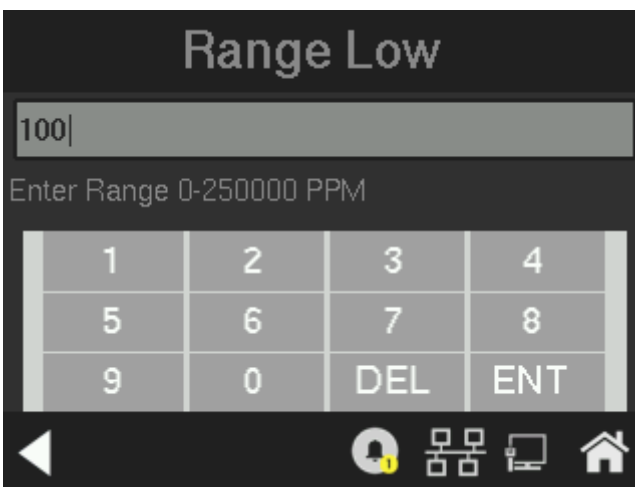



The LOW range extends from 0-250,000 ppm.

1. Click the “DEL” button to delete the one character at a time from the Edit box.
2. Click the “ENT” Button to store the values and move back to the parent (Range) screen.
3. Click the “back arrow” to move to the Range screen without saving any edited values.

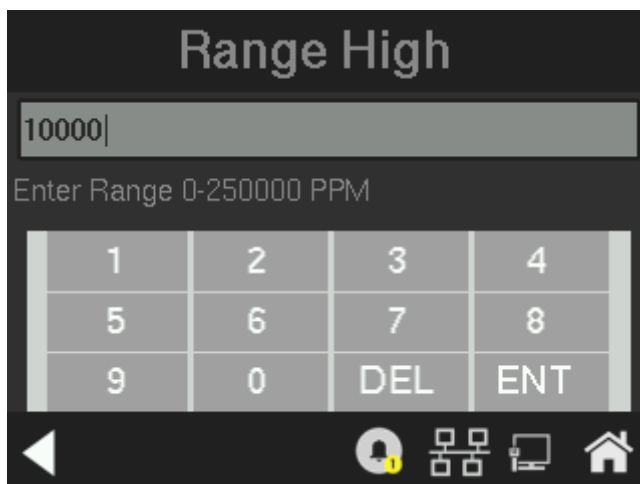
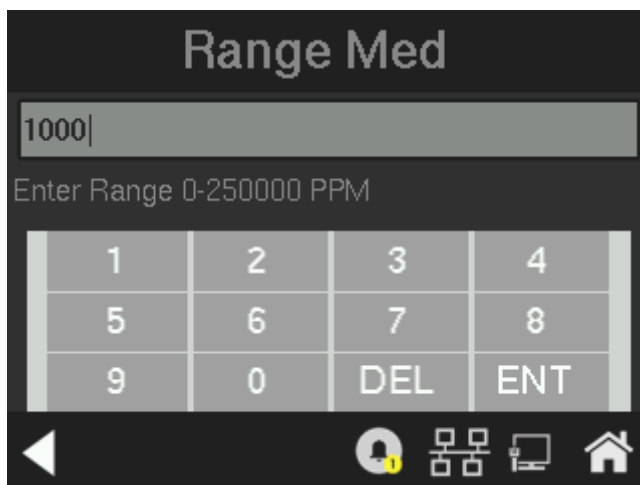
Use the same procedure for setting or changing the Medium and High Ranges.



The Range screen has Reset, Save, and Back buttons.

1. Clicking on the Reset button  will revert back to the old values and any changes that have been made will not be saved.
2. Clicking on the Save button  will save the newly entered values.
3. Clicking on home button  will move the display to the Main screen without saving the edited values.

- Clicking on the back button  will move the display back to the System screen. If any changes have been entered, a message box will appear requesting: “Do you want to Save the changes?” Use the Yes or No buttons to reply.

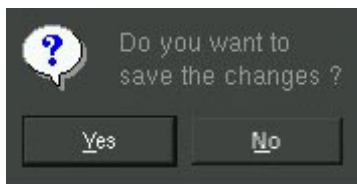

- “Yes” will save user entered values and move to the System screen.
- “No” will discard the changes and move to System screen.

4.6.2 Fixed Range Analysis

The auto ranging mode of the instrument can be overridden, forcing the analyzer DC outputs to stay in a single predetermined range.

To switch from auto ranging to fixed range analysis, enter the range function by pressing the Range button and toggle the Range Type from AUTO to FIXED.

Note: When performing analysis on a fixed range, if the oxygen concentration rises above the upper limit (or default value) as established by the operator for that particular range, the output saturates at 1 VDC (or 20 mA). However, the digital readout and the RS-232 output continue to read the true value of the oxygen concentration regardless of the analog output range.

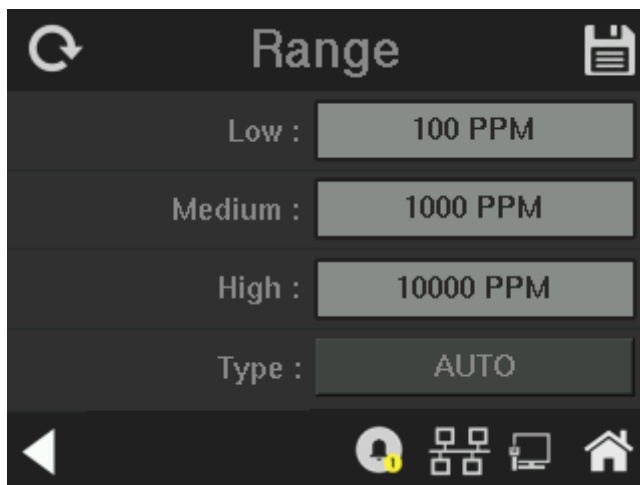

4.7 Alarm Function

The Model 3000RS-TXL is equipped with 2 fully adjustable concentration alarms and a system failure alarm. Each alarm has a relay with a set of form “C” contacts rated for 100V AC/DC at 1 Amp (Secondary power Pollution DEGREE 2). See Figure in Chapter 3, Installation and/or the Interconnection Diagram included at the back of this manual for relay connections.

The system failure alarm has a fixed configuration described in Chapter 3 Installation.

The concentration alarms can be configured from the display as either high or low alarms by the operator. The alarm modes can be set as latching or non-latching, and either failsafe or non-failsafe, or, they can be defeated altogether. The setpoints for the alarms are also established using this function.

Decide how your alarms should be configured. The choice will depend upon your process. Consider the following four points:

1. Which if any of the alarms are to be high alarms and which if any are to be low alarms?
Setting an alarm as HIGH triggers the alarm when the oxygen concentration rises above the setpoint. Setting an alarm as LOW triggers the alarm when the oxygen concentration falls below the setpoint.

Decide whether you want the alarms to be set as:

- Both high (high and high-high) alarms, or
 - One high and one low alarm, or
 - Both low (low and low-low) alarms.
- Are either or both of the alarms to be configured as failsafe?
In failsafe mode, the alarm relay de-energizes in an alarm condition. For non-failsafe operation, the relay is energized in an alarm condition. You can set either or both of the concentration alarms to operate in failsafe or non-failsafe mode.
2. Are either of the alarms to be latching?
In latching mode, once the alarm or alarms trigger, they will remain in the alarm mode even if process conditions revert to non-alarm conditions. This mode requires an alarm to be recognized before it can be reset. In the non-latching mode, the alarm status will terminate when process conditions revert to non- alarm conditions.
 3. Are either of the alarms to be defeated?
The defeat alarm mode is incorporated into the alarm circuit so that maintenance can be performed under conditions which would normally activate the alarms.
The defeat function can also be used to reset a latched alarm.
(See procedures, below.)

If you are using password protection, you will need to enter your password to access the alarm functions. Follow the instructions in section 4.3.3 to enter your password. Once you have clearance to proceed, enter the Alarm function.

Press the Alarm button on the Menu screen to enter the Alarm function.

Menu screen:

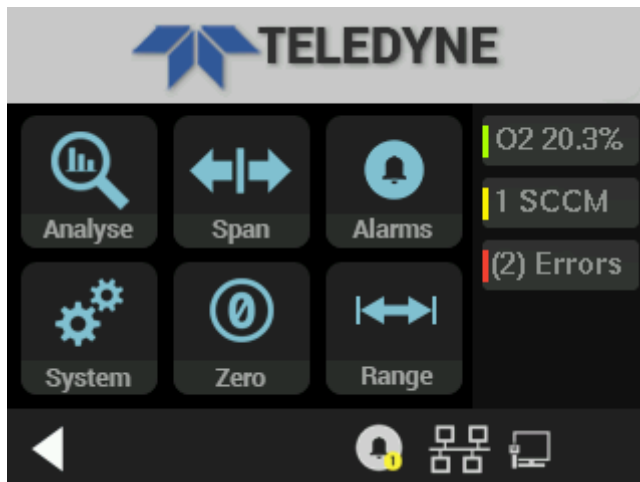

Alarms screen:

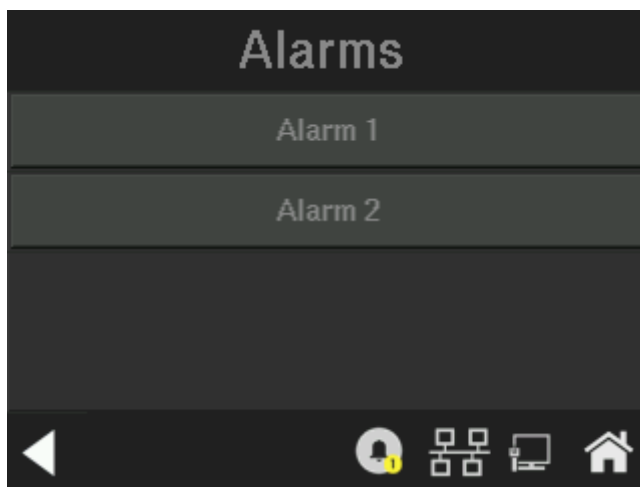

To define the alarm parameters, touch the ALARM 1 or ALARM 2 edit box to bring up the alarm configuration screen for that alarm.

Five parameters can be changed on this and the second alarm configuration screen plus an alarm status:

- Value of the alarm setpoint, AL-1 ##### ppm (oxygen)

- Out-of-range direction, **HI** or **LO**
- Defeated? Dft–**Y/N** (Yes/No)
- Failsafe? Fs–**Y/N** (Yes/No)
- Latching? Ltch–**Y/N** (Yes/No).

Use the scroll bar to view the last two items.

Alarm 1 configuration screen 1:

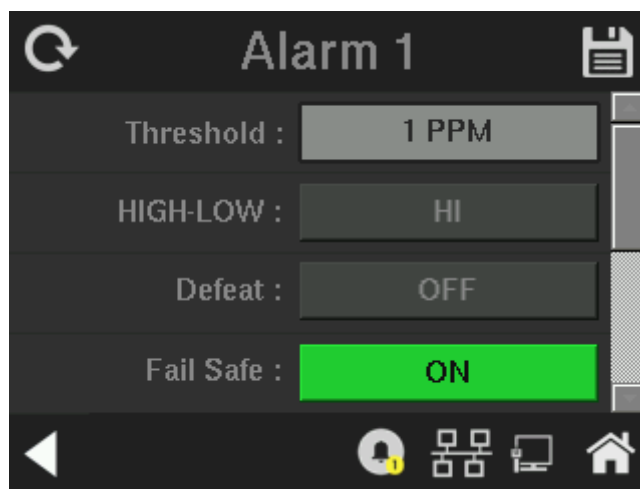

4.7.1 Alarm Setpoint

To define the alarm setpoint, touch the ALARM 1 or ALARM 2 Threshold edit box to bring up a numerical keypad.

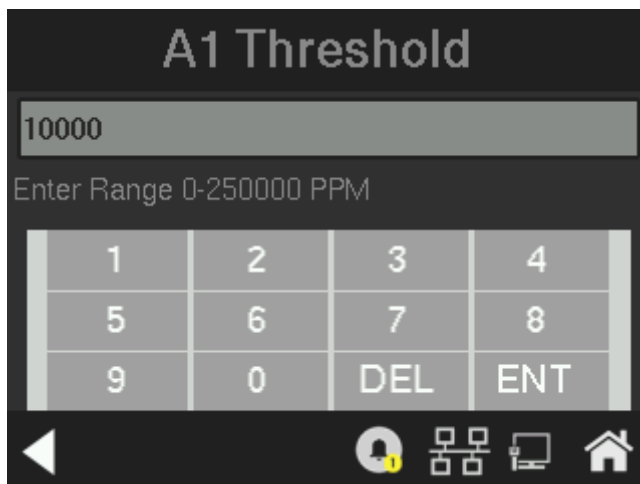
Alarm 1 Threshold set:

Note: Alarm 1 is shown, Alarm 2 is identical.

Enter the alarm setpoint using the keypad.

1. Click the “DEL” button to delete the one character at a time from the Edit box.
2. Click the “ENT” Button to store the values and move back to the parent (Range) screen.
3. Click the “back arrow” to move to the Alarm screen without saving any edited values.

Use the same procedure for setting Alarm 1 or Alarm 2 setpoint. (Remember, the setpoint units are ppm O₂.) To set the other alarm parameters touch the edit box for the parameter.

4.7.2 HI/LOW Alarm

To set whether the alarm is a HIGH or LOW alarm, touch the HIGH/LOW edit box and toggle the value to the desired configuration.

4.7.3 Alarm Defeat

The user can defeat either or both the alarms by toggling the Defeat edit box between OFF (defeat) or ON (active).

4.7.4 Failsafe/Non-Failsafe Mode

The user can set either or both the alarms to operate in failsafe or non-failsafe mode by toggling the value in the edit box.

4.7.5 Latching/Non-Latching Alarm

The user can set whether the alarms will be latching or non-latching by toggling the value (ON = Latching/OFF = non-latching) in the edit box.

1. ON- Once the alarm or alarms trigger, it will remain in the alarm mode even if process conditions revert to non-alarm conditions. This mode requires an alarm to be recognized before it can be reset.
2. OFF - The alarm status will terminate when process conditions revert to non-alarm conditions.



An alarm is recognized by touching the Alarm icon on the Main screen.

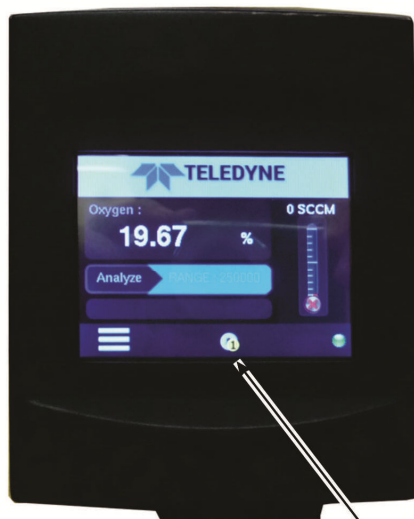

Alarm Indicator

4.7.6 Alarm Status

The Alarm Status is non-editable option. It is used to view the status of whether a concentration alarm is active or not.

1. When alarm is active (alarm triggered), it will show “Reset Alarm 1” or “Reset Alarm 2”. If the alarm is inactive, it will not show the Reset Alarm touch button.
2. Reset: Touch the Alarm Indicator icon on the Main screen to reset the active alarm.

4.8 The Zero and Span Functions

Note: Zeroing is not required to achieve the published accuracy specification of this unit.

Zeroing will eliminate offset error contributed by sensor, electronics, and internal and external sampling system and improve performance beyond published specification limits.

The analyzer is calibrated using zero and span gases.

Any suitable oxygen-free gas can be used for zero gas provided it is known to be oxygen free and does not react adversely with the sample system.

Although the instrument can be spanned using air, a span gas with a known oxygen concentration in the range of 70–90% of full scale of the range of interest is recommended. Since the oxygen concentration in air is 20.9% (209,000 ppm), the cell can take a long time to recover if the instrument is used for trace oxygen analysis immediately following calibration in air.

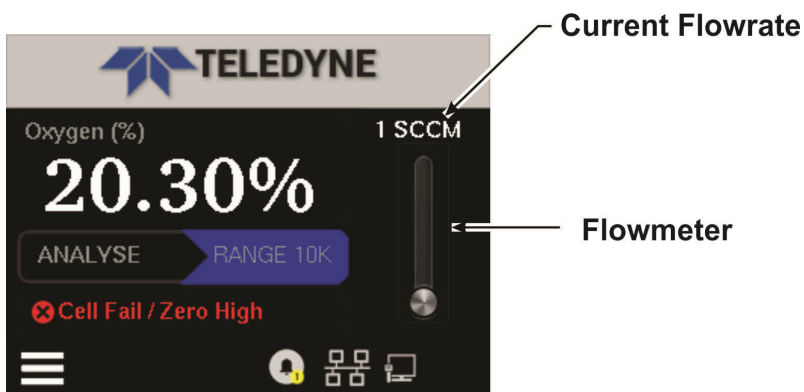

Connect the calibration gases according to the instructions given in Section 3.3.1, *Gas Connections*, observing all the prescribed precautions.

Shut off the gas pressure before connecting it to the analyzer and be sure to limit the pressure to 40 psig or less when turning it back on.

Readjust the gas pressure into the analyzer until the flowrate (as read on the *Main* screen settles between 150 and 2400 SLPM (approximately 0.2 - 5 SCFH).

If you are using password protection, you will need to enter your password to gain access to either of these functions. Follow the instructions in Sections 4.5.1 to enter your password. Once you have gained clearance to proceed, you can enter the *Zero* or *Span* function.

4.8.1 Zero Cal

The *Zero* button on the Menu screen is used to enter the Zero calibration function. Zero calibration can be performed in either the automatic or manual mode. In the **automatic** mode, an internal algorithm compares consecutive readings from the sensor to determine when the output is within the acceptable range for zero. In the **manual** mode, the operator determines when the reading is within the acceptable range for zero. Make sure the zero gas is connected to the instrument.

Make sure the Zero calibration gas source is connected to the instrument (see Section 3.3.1). Press the Zero button on the Menu screen to enter the Zero Calibration function.

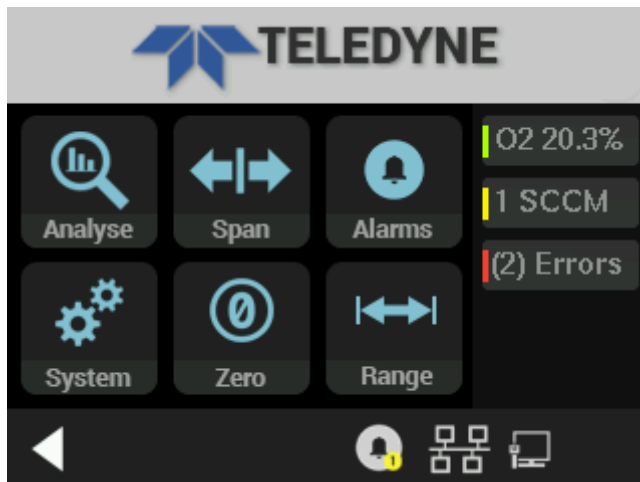
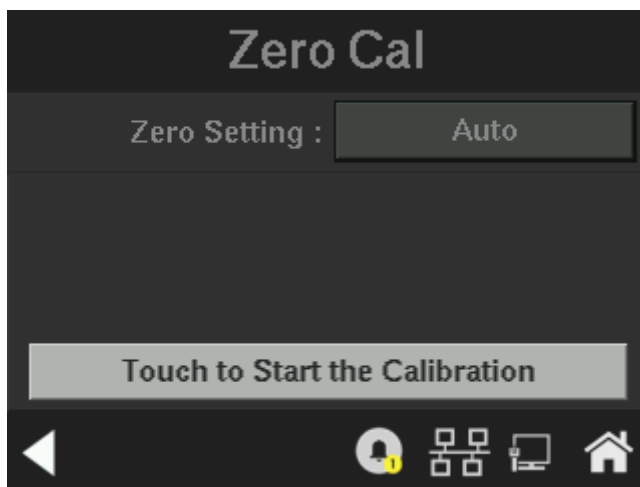
Menu screen:**Zero Cal screen 1:**

- A. The Zero Cal screen is used to select the Zero calibration mode - AUTO or MANUAL
- B. Click the “Zero Setting” edit box to toggle between “AUTO” and “MANUAL”.
 1. AUTO : Auto mode will calculate the calibration offset automatically.
 2. MANUAL: Selecting manual mode, the user must press “ENTER” to save calculated calibration offset.

- C. Click on “Touch to Start the Calibration” to start the calibration process. Details about manual and auto calibration run screens are detailed below.

4.8.1.1 AUTO MODE ZEROING

When the Zero calibration mode is set to Auto and the “Touch to Start the Calibration” button is pressed, the Zero Auto Run screen is displayed.

Zero Calibration Run screen:

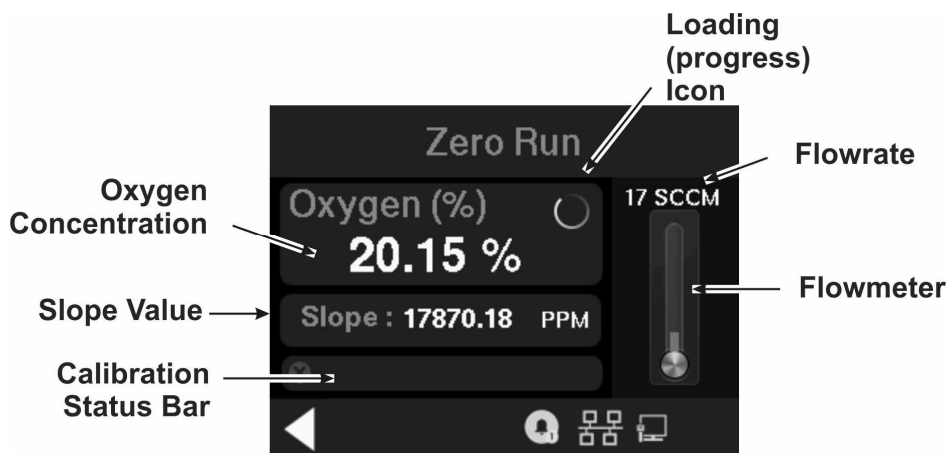

The following items are contained within the Zero calibration auto mode run screen:

1. Calibration is in progress icon.
2. Oxygen % values.
3. Slope values.
4. Calibration status bar.
5. Flowmeter with flowrate and status.

The Calibration in Progress icon will appear only in the Auto calibration mode. It means that a calibration is in progress. When the calibration is finished or if an error occurs, the icon will stop refreshing.

The current oxygen concentration (in percent) will be updated in the Oxygen % field as will the slope as calibration proceeds.

The flowmeter display is used to show the current flow rate and the trend in flow (fluctuating, stable, etc.). It shows the current flow values based on scale factor. Low scale limit = 0 and the High scale limit = 100.

The Calibration status bar displays calibration progress messages as well as any errors that may occur.

1. Message 1: “**Calibration Progress**” - This message displays in the Status bar as the calibration begins.
2. Message 2: A calibration countdown displays as: “**Calibration 5 Left**”, “**Calibration 4 Left**” etc. and is based on the currently calculated gain offset.
3. Message 3: Error messages
 - “**Error: Zero Failed!**” - Zero calibration has failed.
 - “**Error: Input Still Too High**” - Calibration aborted while doing gain switching.
 - “**Error: Can't Zero Flow Failed**” - This error appears if there has been a flow failure during the calibration.
4. Message 4: “**Calibration done**” - This indicates that the Zero calibration has successfully completed without any errors.

The Zero Calibration Run screen has a Back arrow button  that when pressed DURING A CALIBRATION will bring up a display which will allow the abort the calibration without saving. Use the Yes or No buttons to reply.

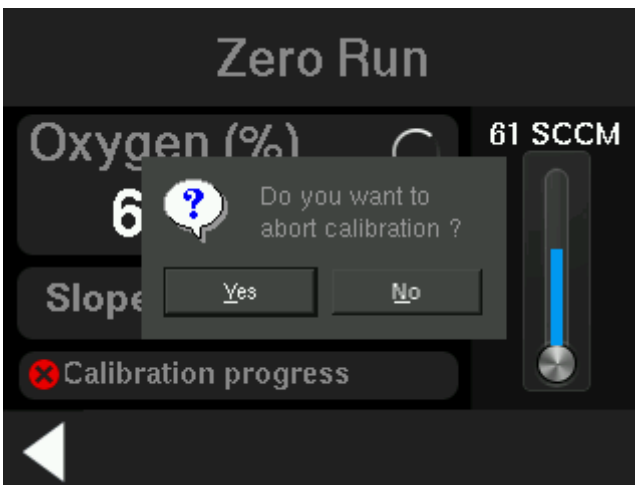

- “Yes” will ABORT the calibration and move back to the Menu screen.
- “No” will continue the calibration.

After the calibration has FINISHED, pressing the Back arrow button will bring up a similar requester.

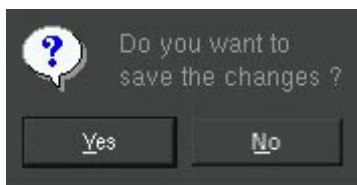

- “Yes” will save the calibration values and return to the System screen.
- “No” will discard the changes and move to System screen.

4.8.1.2 MANUAL MODE ZEROING

When the Zero calibration mode is set to MAN and the “Touch to Start the Calibration” button is pressed, the Zero Run screen is displayed.

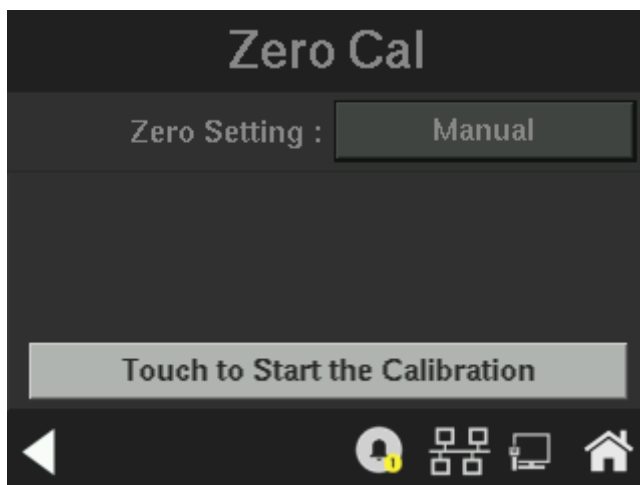
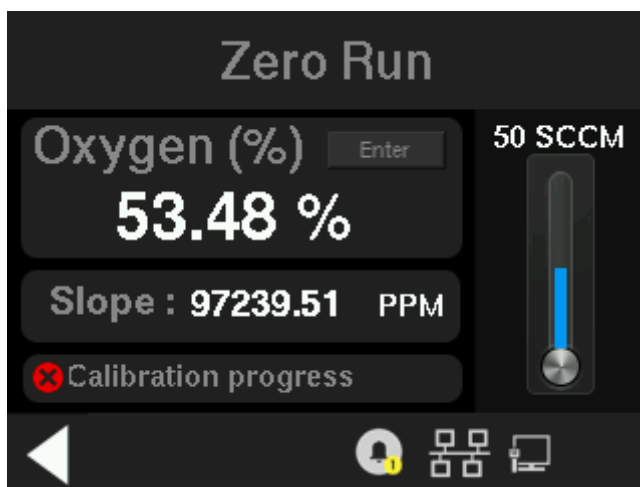
Zero Cal screen 1:**Zero Cal Manual Mode Run screen:**

The following items are contained within the Zero calibration manual mode run screen:

1. Calibration manual ENTER button.
2. Oxygen % values.
3. Slope values
4. Calibration status bar.
5. Flow meter with flowrate and status.

Except for the manual ENTER button all remaining options are the same as for the AUTO mode. See section 4.4.1.1 for descriptions.

The Manual Calibration ENTER button is used to save the calibration offset values and will only appear in the Manual calibration mode.

Generally, you have a good zero when Slope is less than 0.05 ppm/s for about 30 seconds. When Slope is close enough to zero, press ENTER. In a few seconds, the screen will update. Once span settling completes, the information is stored in the microprocessor.

The Zero Calibration Run screen has a Back arrow  that when pressed DURING A CALIBRATION will bring up a display which will allow the abort the calibration without saving. Use the Yes or No buttons to reply.

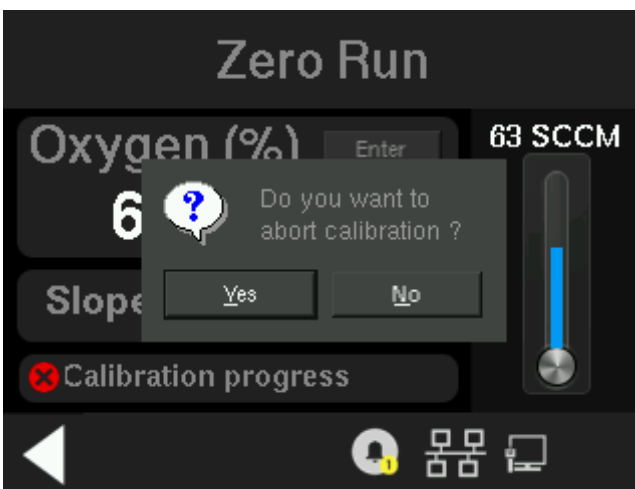

- “Yes” will ABORT the calibration and move back to the Menu screen.
- “No” will continue the calibration.

After the calibration has FINISHED, pressing the Back arrow button will bring up a similar requester.

S

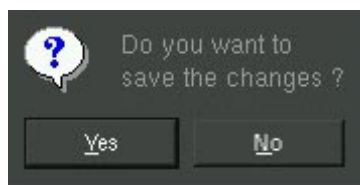

- “Yes” will save the calibration values and return to the System screen.
- “No” will discard the changes and move to System screen.

4.8.2 *Span Cal*

The *Span* button on the Menu screen is used to span calibrate the analyzer. Span calibration can be performed using the **automatic** mode, where an internal algorithm compares consecutive readings from the sensor to determine when the output matches the span gas concentration. Span calibration can also be performed in **manual** mode, where the operator determines when the span concentration reading is acceptable and manually exits the function. Make sure the appropriate span gas source is connected to the analyzer. See Section 3.3.1.

4.8.2.1 AUTO MODE SPANNING

Press *Span* to enter the span function.

Menu screen:

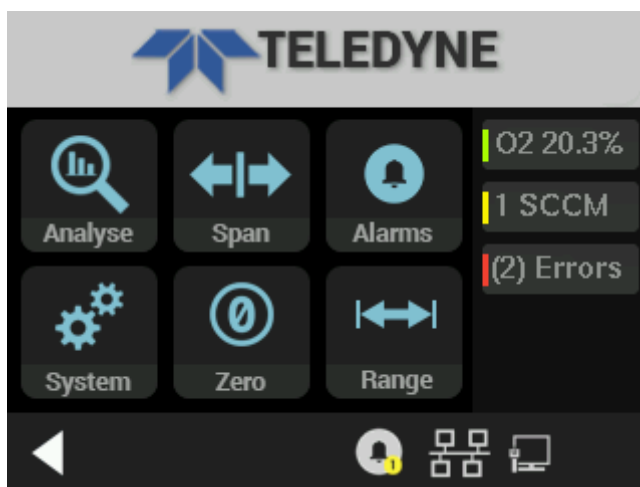

The screen that appears allows you to select whether the span calibration is to be performed automatically or manually.

This screen also allows the operator to set the time the analyzer should be held in the span mode after the readings of the analyzer settle. Five minutes is the default, but it could be adjusted anywhere from 1 to 60 minutes by user.

This screen is also used to enter the span concentration of the calibration gas.

Span Cal configuration screen:

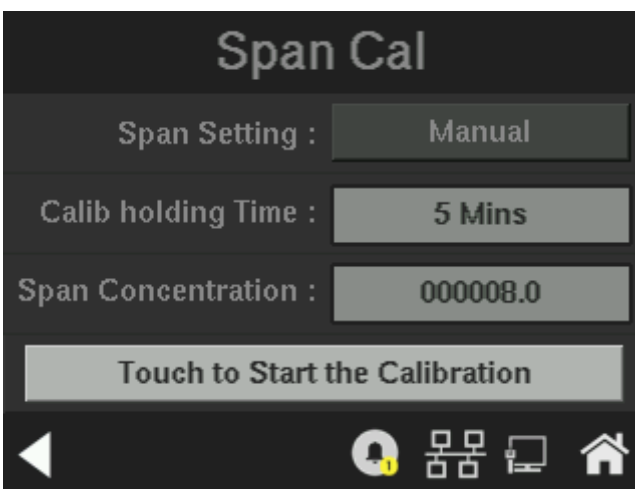

In addition to setting the manual or automatic span mode and the calibration hold time, this menu.

Calibration Hold Time:

To set the calibration hold time in minutes, touch the corresponding edit box to bring up the numerical pad.

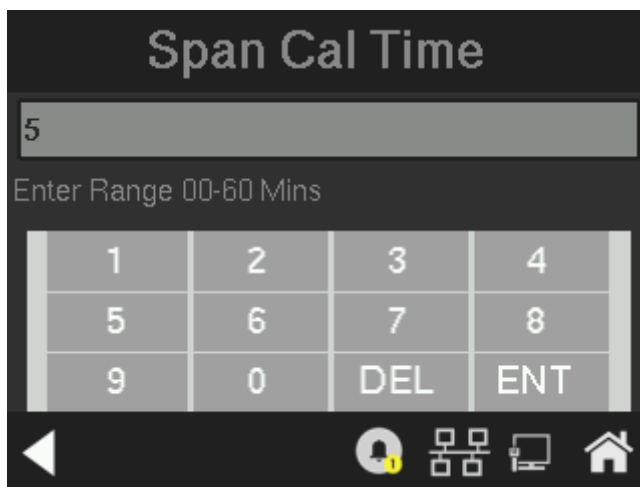

Enter the hold time using the keypad. Select hold time in the 10 to 15 minutes range is recommended.

1. Click the “DEL” button to delete the one character at a time from the Edit box.
2. Click the “ENT” Button to store the values and move back to the parent Span Cal screen.
3. Click the “back arrow” to move to the Span Cal screen without saving any edited values.

Calibration Concentration Value:

To enter or check the Span Concentration of the calibration gas touch the corresponding edit box to bring up the numerical pad.

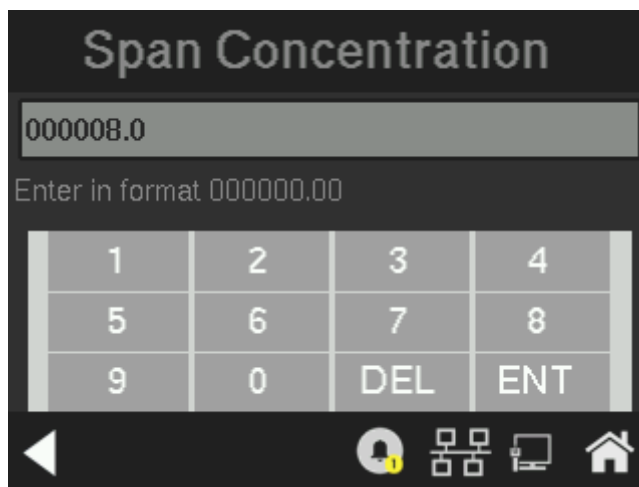

Enter the oxygen concentration using the same procedure as for the Cal holding time described above. When you have finished typing in the concentration of the span gas you are using in ppm (209000.00 if you are using air), press ENT to save the value or the back arrow to discard the entry and dismiss the numerical pad.

Start the Calibration:

To begin the Span calibration, touch the corresponding box on the Span Cal screen.

Span Cal Run screen:

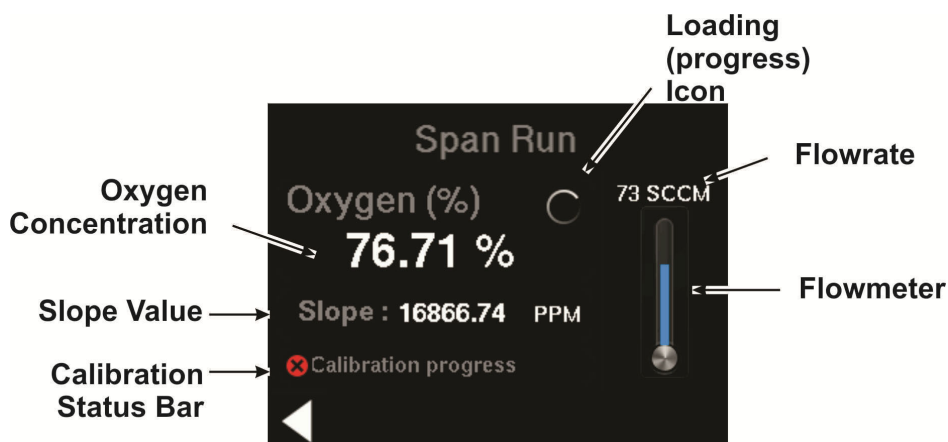

The beginning span value is shown in the oxygen display box along with a span in progress icon that constantly updates as the calibration proceeds.

The flow rate of the span gas is displayed to the right along with a simulated flowmeter to assess the flow trend. As the span reading settles, the screen displays and updates information on **Slope**. Spanning automatically ends when the span output corresponds, within tolerance, to the value of the span gas concentration. Then the instrument automatically returns to the Main screen.

Note: If there is insufficient or no flow, you will not be able to perform a zero or span calibration. If this condition occurs, a screen will appear for a few seconds indicating that the calibration could not be performed due to a flow alarm.

The following items are contained within the Span calibration auto mode run screen:

1. Calibration is in progress icon.
2. Oxygen % values.
3. Slope values.
4. Calibration status bar.
5. Flow meter with flowrate and status.

The Calibration in Progress icon will appear only in the Auto calibration mode. It means that a calibration is in progress. When the calibration is finished or if an error occurs, the icon will stop refreshing.

The current oxygen concentration (in percent) will be updated in the Oxygen % field as will the slope as calibration proceeds.

The flowmeter display is used to show the current flow rate and the trend in flow (fluctuating, stable, etc.). It shows the current flow values based on scale factor. Low scale limit = 0 and the High scale limit = 100.

The Calibration status bar displays calibration progress messages as well as any errors that may occur.

1. Message 1: “**Calibration Progress**” - This message displays in the Status bar as the calibration begins.

2. Message 2: A calibration countdown displays as: “**Calibration 5 Left**”, “**Calibration 4 Left**” etc. and is based on the currently calculated gain offset.
3. Message 3: Error messages
 - “**Error: Span Failed!**” - Zero calibration has failed.
 - “**Error: Input Still Too High**” - Calibration aborted while doing gain switching.
 - “**Error: Can't Zero Flow Failed**” - This error appears if there has been a flow failure during the calibration.
5. Message 4: “**Calibration done**” - This indicates that the zero calibration has successfully completed without any errors.

The Span Calibration Run screen has a Back arrow button  that when pressed DURING A CALIBRATION will bring up a display which will allow the abort the calibration without saving. Use the Yes or No buttons to reply.

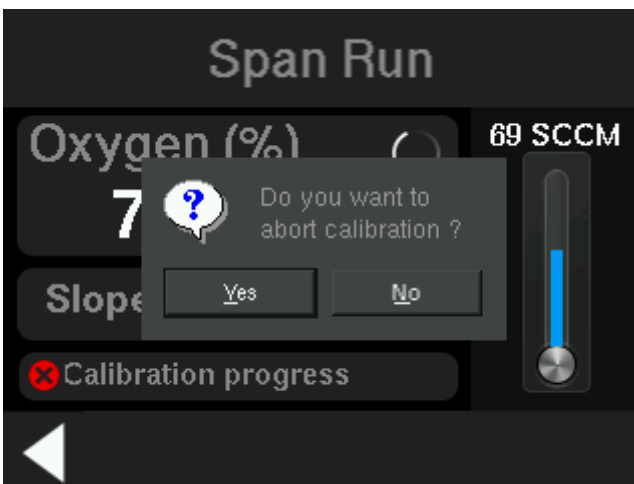

- “Yes” will ABORT the calibration and move back to the Menu screen.
- “No” will continue the calibration.

After the calibration has FINISHED, pressing the Back arrow button will bring up a similar requester.

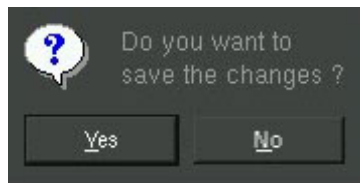

- “Yes” will save the calibration values and return to the System screen.
- “No” will discard the changes and move to System screen.

4.8.2.2 SPAN MANUAL MODE RUN SCREEN

When the Span calibration mode is set to MAN and the “Touch to Start the Calibration” button is pressed, the Span Run screen is displayed.

Span Cal Manual Mode Run screen:

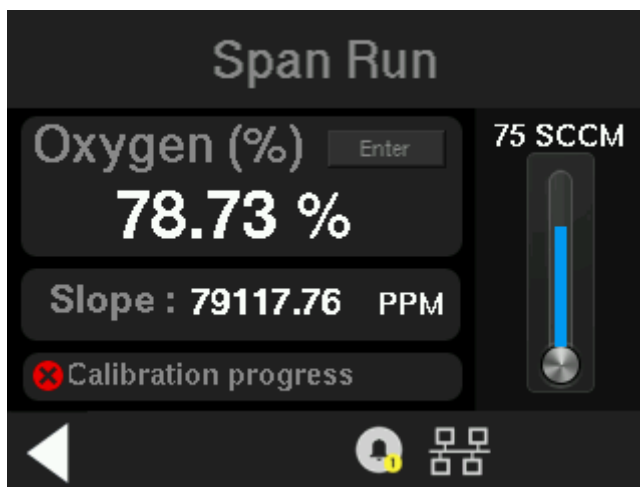

The following items are contained within the Span Calibration Manual Mode Run screen:

1. Calibration manual ENTER button.
2. Oxygen % values.
3. Slope values.
4. Calibration status bar.

5. Flow meter with flowrate and status.

Except for the manual ENTER button all remaining options are the same as for the AUTO mode. See section 4.8.2.1 for descriptions.

The Manual Calibration ENTER button is used to save the calibration offset values and will only appear in the Manual calibration mode.

Use the arrow buttons to enter the oxygen concentration of the span gas you are using (209000.00 if you are using air). When Slope is close enough to zero, press ENTER. In a few seconds, the screen will update.

Once the span has begun, the microprocessor samples the output at a predetermined rate. It calculates the difference between successive samplings and displays this difference as Slope on the screen. It takes several seconds for the first Slope value to display. Slope indicates rate of change of the Span reading. It is a sensitive indicator of stability. Once span settling completes, the information is stored in the microprocessor.

The Span Calibration Run screen has a Back arrow  that when pressed DURING A CALIBRATION will bring up a display which will allow the abort the calibration without saving. Use the Yes or No buttons to reply.

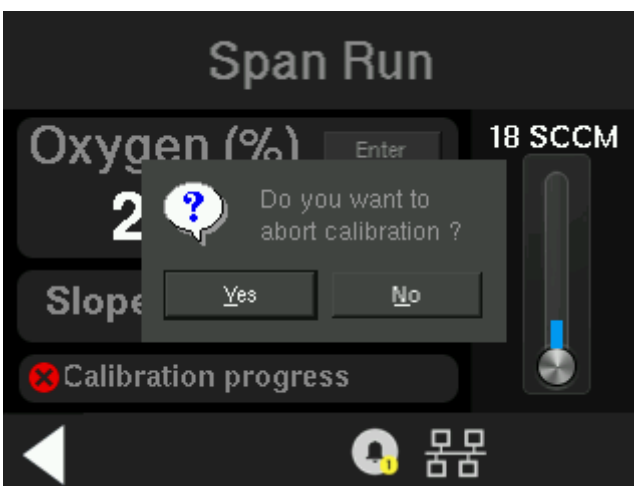

- “Yes” will ABORT the calibration and move back to the Menu screen.

- “No” will continue the calibration.

After the calibration has FINISHED, pressing the Back arrow button will bring up a similar requester.

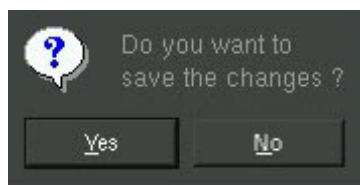

- “Yes” will save the calibration values and return to the System screen.
- “No” will discard the changes and move to System screen.

4.9 Maintenance Schedule

This feature is to add a reminder in the software for the operator to perform some sort of maintenance on the analyzer after some elapse time. This feature could be used to remind operators that it might be time to replace the sensor before its useful time is depleted.

To set the maintenance reminder, the operator must set the time and start the counter by setting up the “**Maint Schedule**” function in the system menu.

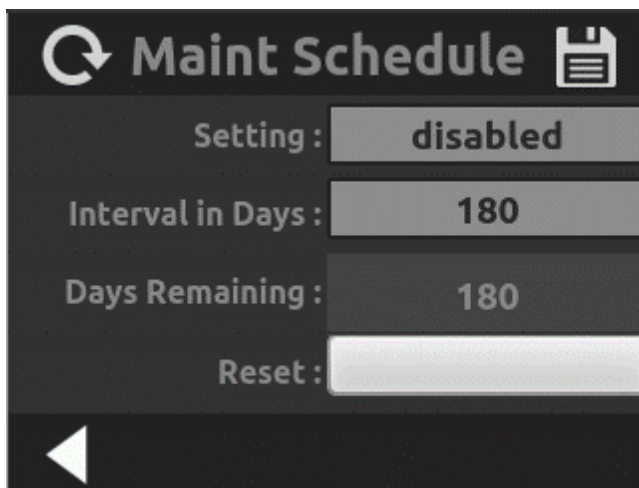

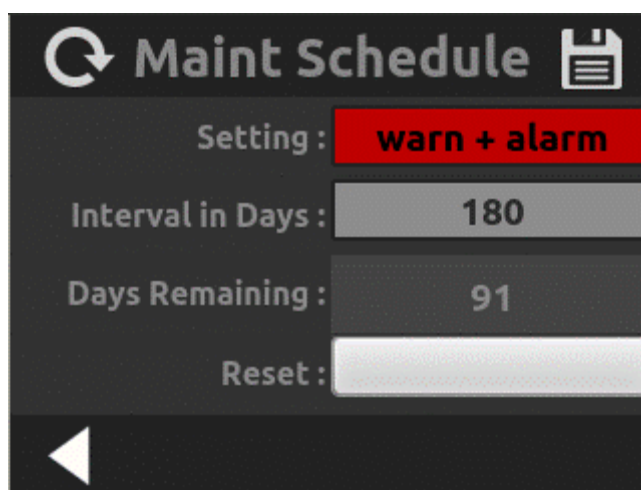
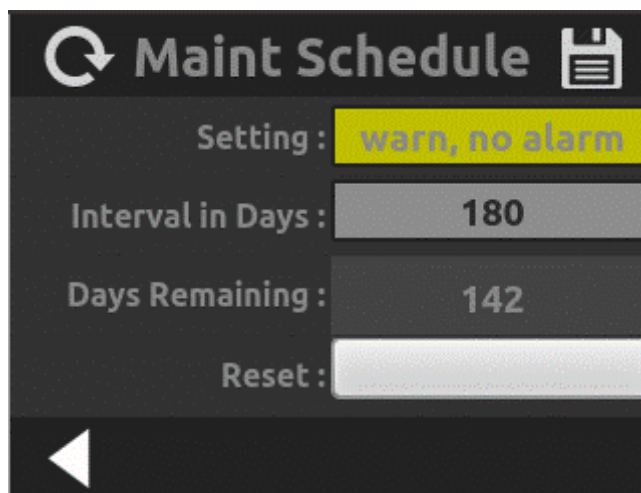

There are three Setting choices: “disabled”, “warn, no alarm”, and “warn + alarm”.

- **disabled:** The counter is disabled; no warning is displayed.
- **warn, no alarm:** In this case when the counter of days drops to zero a message is displayed on the main screen, but the system alarm is not triggered. In this case it is a less forceful reminder.
- **Warn + alarm:** In this case when the counter of days drops to zero a message is displayed on main screen, but the system alarm is triggered. This is a more forceful reminder.

Interval of days is set by default to 180 days, but its value can be changed by operator.

Days Remaining shows the number of days remaining in the counter before the warning is triggered.

The Reset button can be used to reset the counter back to the value of interval of days.

If setting or Interval of days is changed, press the floppy disk icon to save the setting. Changing the interval of days and saving it will automatically reset the counter of days remaining.

4.10 No Sensor Detection Feature, Sensor Fail

This feature tries to detect whether a sensor is installed in the analyzer or not. The software checks if the output of the amplifier is inside a window around electronic zero level (output of the amplifier without sensor). If it is, a 30-minute counter starts at the end of which a warning is displayed, and system alarm is triggered. If output rises above the electronic zero detection window, during the countdown, the counter is reset back to 30 minutes.

To set the feature the operator must find the “**Sensor Fail**” function in the system menu.

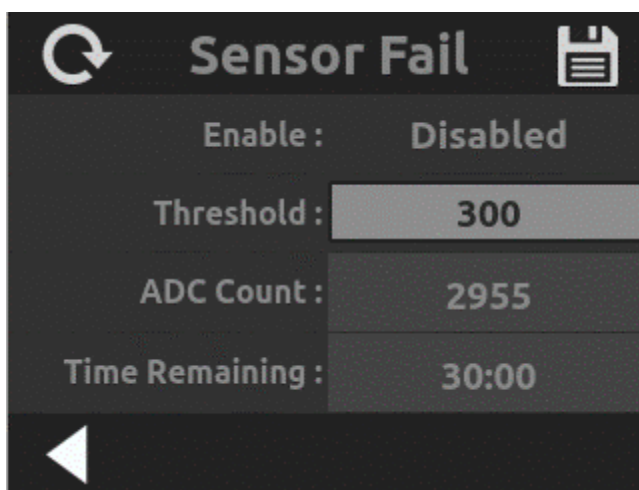

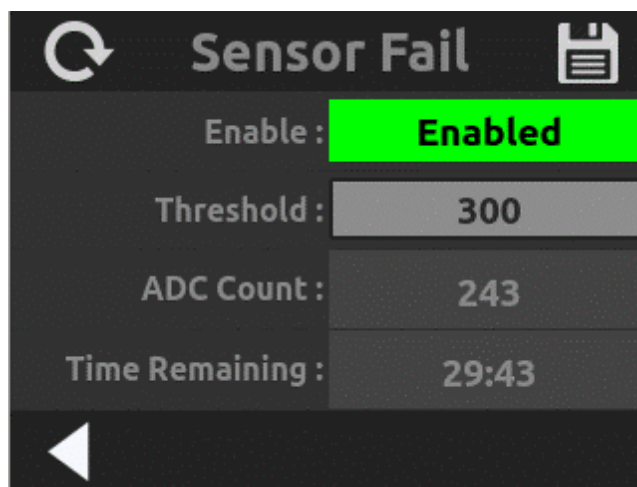

The function can be disabled in this menu, but if the function is enabled and it is triggered, the main will display the sensor fail message as well as the system alarm will be triggered.

The threshold value must be selected to properly detect there is no sensor in the cell block. If the threshold value selected is too low, it may never trigger due to noise resetting the “Time Remaining” counter and if value is too high it may set the alarm unnecessarily.

To make sure that the threshold is above electronic noise, select a value that is above ADC count value shown on this function when no sensor is installed. Double or tripled the value of ADC count so that threshold is above noise or electronic drift.

Time Remaining counter remains at 30:00 if ADC count does not go below the threshold and starts counting down when it does.

False Alarm is still possible with a sensor installed in the analyzer if a sensor offset is so low that it drops below the threshold value. This is rare but it can happen. There is no recourse if this is occurring other than disabled the feature provided sensor installation has been verified.

5 Maintenance

5.1 Routine Maintenance

Aside from normal cleaning and checking for leaks at the gas connections, routine maintenance is limited to replacing Micro-Fuel cells and fuses, and recalibration. For recalibration, see Section 4.8 *The Zero and Calibration Functions*.

WARNING: SEE WARNINGS ON THE TITLE PAGE OF THIS MANUAL.



5.2 Cell Replacement

The Micro-Fuel Cell used in this analyzer is a sealed electrochemical transducer with no electrolyte to change or electrodes to clean. When the cell reaches the end of its useful life, it is replaced. The spent fuel cell should be discarded according to local regulations. This section describes fuel cell care as well as when and how to replace it.

5.2.1 Storing and Handling Replacement Cells

To have a replacement cell available when it is needed, it is recommended that one spare cell be purchased 9-10 months after commissioning the 3000RS-TXL, or shortly before the end of the cell's one year warranty period.

CAUTION: DO NOT STOCKPILE CELLS. THE WARRANTY PERIOD STARTS ON THE DAY OF SHIPMENT.



The spare cell should be carefully stored in an area that is not subject to large variations in ambient temperature (75°F nominal, 24°C) or to rough handling.

WARNING: **THE SENSOR USED IN THE MODEL 3000RS-TXL TRACE OXYGEN ANALYZER USES ELECTROLYTES WHICH CONTAIN TOXIC SUBSTANCES, MAINLY LEAD AND POTASSIUM HYDROXIDE, THAT CAN BE HARMFUL IF TOUCHED, SWALLOWED, OR INHALED. AVOID CONTACT WITH ANY FLUID OR POWDER IN OR AROUND THE UNIT. WHAT MAY APPEAR TO BE PLAIN WATER COULD CONTAIN ONE OF THESE TOXIC SUBSTANCES. IN CASE OF EYE CONTACT, IMMEDIATELY FLUSH EYES WITH WATER FOR AT LEAST 15 MINUTES. CALL PHYSICIAN. (SEE APPENDIX, MATERIAL SAFETY DATA SHEET.)**



CAUTION: **DO NOT DISTURB THE INTEGRITY OF THE CELL PACKAGE UNTIL THE CELL IS TO ACTUALLY BE USED. IF THE CELL PACKAGE IS PUNCTURED AND AIR IS PERMITTED TO ENTER, THE CELL WILL REQUIRE AN EXCESSIVELY LONG TIME TO REACH ZERO AFTER INSTALLATION (1-2 WEEKS!).**



5.2.2 When to Replace a Cell

The characteristics of the Micro-Fuel Cell show an almost constant output throughout its useful life and then fall off sharply towards zero at the end. Cell failure in the 3000RS-TXL is usually characterized inability to zero the instrument down to a satisfactorily low ppm reading.

Before replacing the cell:

- A. Check your span gas to make sure it is within specifications.
- B. Check for leaks downstream from the cell, where oxygen may be leaking into the system.

If there are no leaks and the span gas is OK, replace the cell.

5.2.3 Removing the Micro-Fuel Cell

The Micro-Fuel cell is located inside the cell block behind the front door (see Figure 2-1). To remove an existing cell:

1. Remove power to the instrument by unplugging the power cable.
2. Open the front panel door by pulling down the top of the door. The door is held in place by a magnetic latch.

3. Lift the latch of the cell holder see Figure 5-1.
4. The cell holder will drop, and the sensor may or may not drop as well. The sensor may be held inside by an internal clip. The clip is facing toward the front, thus, to release the sensor, if it does not drop by itself, just push the bottom of the sensor toward the back slightly and that should release the hold. See Figure 5-2.
5. See Figure 5-3. Depending on sensor used, cell adaptor might not be in.

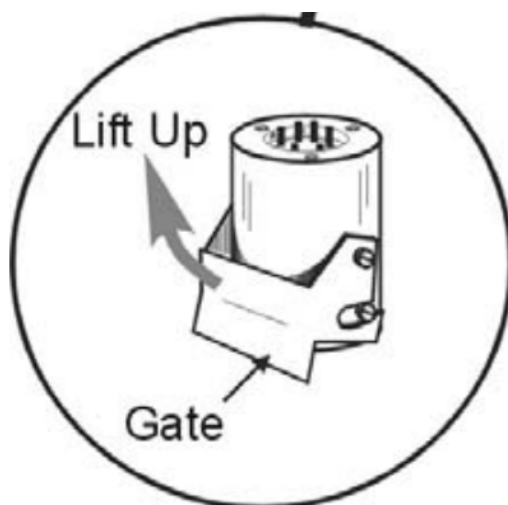

Figure 5-1: Cell Holder

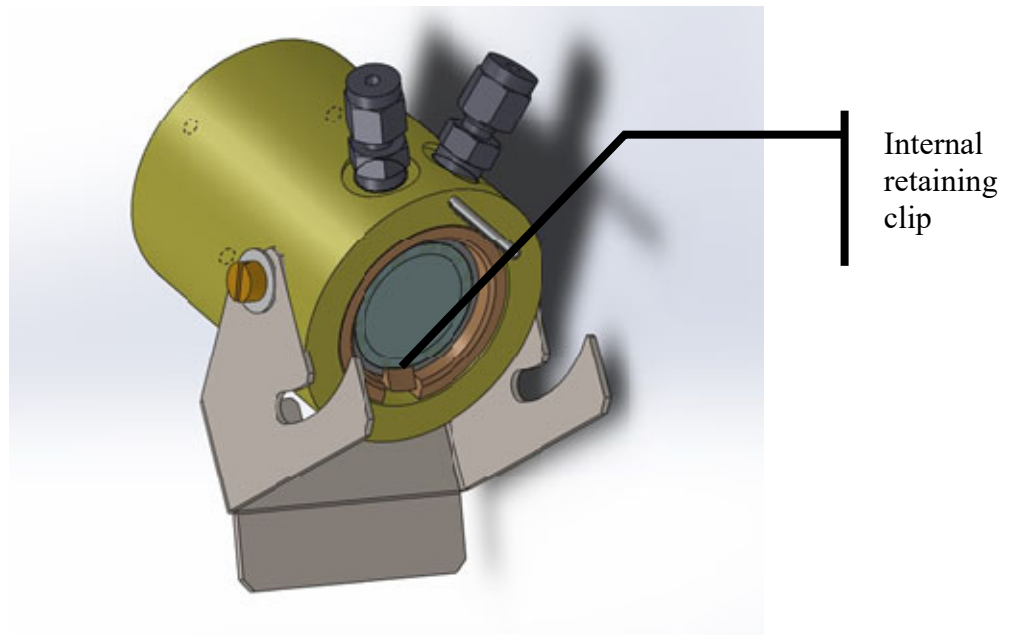

Figure 5-3 Internal retaining arm

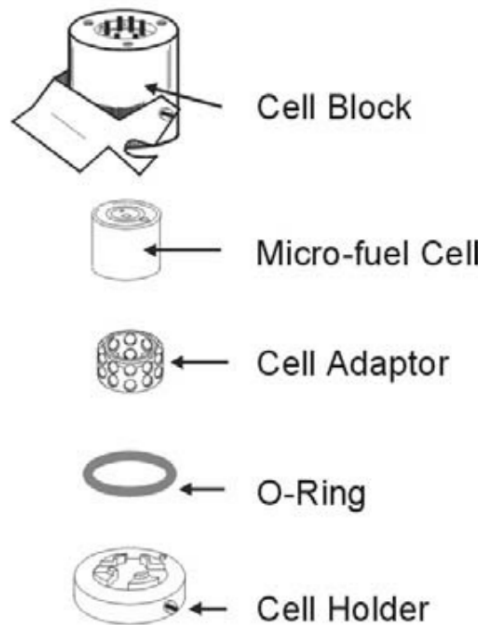

Figure 5-3: Removing the Micro-Fuel Cell

5.2.4 Installing a New Micro-Fuel Cell

It is important to minimize the amount of time that a Teledyne Trace Oxygen Sensor is exposed to air during the installation process. The quicker the sensor can be installed into the unit, the faster your TAI O₂ sensor will recover to low O₂ measurement levels.

This section describes the procedures for removing and installing a conventional trace oxygen sensor such as the A2C, L2C, or B2C.

CAUTION: **DO NOT TOUCH THE SENSING SURFACE OF THE CELL. IT IS COVERED WITH A DELICATE TEFLON MEMBRANE THAT CAN LEAK WHEN PUNCTURED. THE SENSOR MUST BE REPLACED IF THE MEMBRANE IS DAMAGED.**



The cell is a slip-fit into the opening in the cell holder. Place the cell on the holder with the screen side facing down and push into place.

Note: There is a small location hole drilled in the holder. This hole mates with a guide pin on the bottom rear of the cell block. The hole in the cell block holder must align with the guide pin on the cell block.

1. Remove power from instrument.
2. Remove the old sensor (if installed) from the analyser.
3. Purge the analyser at approximately 1000 CCM flow rate with N₂ (or zero gas with the sensor holder removed).
4. Remove sensor from double bag storage.
5. Remove sensor shorting button.
6. Place sensor on sensor holder so that the gold contact plate of the sensor is facing up towards the sky. Place the cell inside and slightly push the bottom of the sensor forward, so it is caught by internal arm of Figure 5-2. If there is a cell adapter, push it inside too and let it be caught by the internal arm by pushing the bottom of it forward too. The adapter is used for short cell such as B2C so that it can make contact on the top of the cell block.
7. Then install the bottom cell holder using the guide screw (back of the cell block body) holder to guide it up in proper orientation See Figure 5-2.
8. Drop latch to secure holder in place.
9. Purge system with sample or zero gas.

10. Power-up.

Note: If steps 4 through 8 are accomplished quickly (elapsed time less than 15 seconds), recovery to less than 1ppm level should occur in less than 8 hours.

5.3 Fuse Replacement

There is no replaceable fuse. Rather, this unit has an internal solid-state fuse with overcurrent protection where it increases resistance with higher temperatures caused by increased current flow, and automatically resets when temperature cools to a safe level.

However, if it persists in preventing the unit from powering on, contact tech support at Teledyne Analytical Instruments for service.

5.4 System Self Diagnostic Test

Refer to Section 4.5.3 to initiate a Self Diagnostic Test.

Table 5-1: Self-Test Failure Codes

Diagnostics	
Test Power:	
Power Testing 5V	PASS
Power Testing 24V	PASS
Power Testing 3.3V	PASS
Power Testing 9V	PASS
Power Testing 4.5V	PASS
Test Analog Output:	
Test Analog Range 4-20mA	PASS
<input type="button" value="Skip"/>	

5.5 Major Internal Components

The Micro-Fuel cell is accessed by pressing the top latch button and swinging the front panel down. Other internal components are accessed by removing the four rear panel screws and sliding out the entire chassis. See Figure 5-4, below. The gas piping is illustrated in

Figure 2-5, and the major electronic component's locations are shown in Figure 2-7, in chapter 2.

WARNING: SEE WARNINGS ON THE TITLE PAGE OF THIS MANUAL.

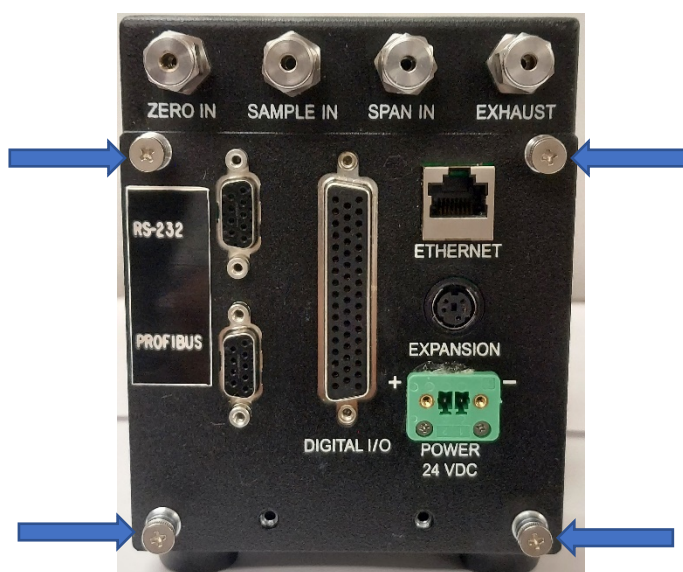

Figure 5-4:

Rear Panel Removal

The 3000RS contains the following major components:

- Analysis Section
 - Micro Fuel Cell (L-2 or other)
 - Stainless steel cell block
- Sample system
- Power Supply
- Microprocessor
- Touch Screen Display
- RS-232, Profibus Communications Ports and Network.

See the drawings in the Drawings section in the rear of this manual for details.

5.6 Cleaning

If instrument is unmounted at time of cleaning, disconnect the instrument from the power source. Close and latch the front-panel access door. Clean outside surfaces with a soft cloth dampened slightly with plain clean water. DO NOT use any harsh solvents such as paint thinner or benzene.

For panel-mounted instruments, clean the front panel as prescribed in the above paragraph. DO NOT wipe front panel while the instrument is controlling your process.

5.7 Troubleshooting

Problem	Possible Cause	Solution
Erratic readings of the Oxygen concentration as reported by the analyzer.	The analyzer may have been calibrated in an inaccurate fashion.	Turn the analyzer off, then back on again. At the startup screen press Factory Reset. when prompted by the analyzer. See Sections 4.2 and 4.2.2. This will return the analyzer to its default settings in calibration and zero values. If erratic behavior continues replace the sensor.
	Atmospheric oxygen may be diffusing in through the vent and affecting the oxygen level which the sensor sees.	Increase flow rate and/or length or vent tubing in order to dilute or minimize the diffusion of oxygen from the vent back to the sensor.
	Inaccurate zero operation (i.e. the user has zeroed the analyzer accidentally on gas much higher	Turn the analyzer off, then back on again. At the startup screen press Factory Reset. when prompted by the analyzer.

	than one would normally use for a zero gas).	See Sections 4.2 and 4.2.2. This will return the analyzer to its default settings in calibration and zero values. Now proceed to carefully calibrate and zero the analyzer.
--	--	---

A Appendix

A.1 Model 3000RS-TXL Specifications

Packaging: General Purpose

- Relay rack mount. Contains up to four instruments in one 19" relay rack chassis (optional).
- Single bench top (optional).

Sensor: Teledyne L-2C, B2C, A2C, B2CXL, or A2CXL trace analysis Micro-Fuel Cell.

Insta-trace option available.

Tubing and fittings: 316 stainless steel.

Ranges: Three user definable ranges from 0–10 ppm to 0–250,000 ppm, plus air calibration range 0- 250,000 ppm (25 %).
Auto ranging with range ID output.

Alarms: One system-failure alarm contact to detect power failure or sensor-zero failure.
Two adjustable concentration threshold alarm contacts with fully programmable setpoints.

Display: User interactive touch screen display.

Digital Interface: Full duplex RS-232 communications port
Profibus Port
LAN port (not implemented).

Power: 24+/-1 VDC, 10 Watts

Operating Temperature: 0-45 °C (32-113 °F)

Accuracy: $\pm 1\%$ of full scale at constant temperature.
 $\pm 5\%$ of full scale over operating temperature range (except 0-10 ppm analysis range) once thermal equilibrium is reached.

± 1 ppm on 0-10 ppm analysis range, once thermal equilibrium is reached.

LDL: 10 ppb at constant flow and temperature

Analog Outputs: User selectable and 4-20 mAdc is adjustable.

0-1 VDC percent-of-range,

0-1 VDC range ID

Or (user selectable)

4-20 mA DC—isolated—percent-of-range,

4-20 mA DC—isolated—range ID.

Dimensions: see outline drawing

A.2 Recommended 2-Year Spare Parts List

Qty	Part Number	Description
1	C94750A	Back Panel PC Board
1	C94756A	Front Panel Touchscreen Interface Board (no touchscreen included)
1	C94759A	Front Panel Interface PCB (no touchscreen included)
1	C94747B	Main PC Board (Trace option)
1	C94747C	Main PC Board (Percent option)
1	C94753B	Mid Plane PCB (3000RS option)
1	O165	O-ring, buna-N
1*		Micro-Fuel Cell
1	CP60	LCD 3.5" Touchscreen
1	A91605	Flow Sensor and Cable Assy.

* See page iii for sensor used in this instrument

Note: Orders for replacement parts should include the part number (if available) and the model and serial number of the instrument for which the parts are intended.

Orders should be sent to:

TELEDYNE Analytical Instruments

16830 Chestnut Street
City of Industry, CA 91748

Phone (626) 934-1500, Fax (626) 961-2538

Web: www.teledyne-ai.com
or your local representative.

A.3 Drawing List

D95707 3000RS/2000RS Outline Drawing

C96118 3000RS single module outline

A.4 Application Notes 3000 Series Analyzers

A.4.1 APPLICATION NOTES ON PRESSURES AND FLOW RECOMMENDATIONS

The 3000 series analyzers require reasonably regulated sample pressures. While the 3000 analyzers are not sensitive to variations of incoming pressure provided they are properly vented to atmospheric pressure. The pressure must be maintained as to provide a useable flow rate through the analyzer. Any line attached to sample vent should be 1/4 or larger in diameter.

A.4.2 FLOW RATE RECOMMENDATIONS:

A usable flow rate for a 3000 series analyzer is one which can be measured by the digital flow sensor. This is basically .2-2.4 SLPM. The optimum flow rate is 1 SLPM.

Note: Response time is dependent on flow rate, a low flow rate will result in slow response to O₂ changes in the sample stream. The span flow rate should be the approximately same as the sample flow rate.

A.4.3 CELL PRESSURE CONCERNS:

The sensors used in 3000 series analyzers are optimized to function at atmospheric pressure. At pressures other than atmospheric the diffusion rate of O₂ will be different than optimum value. Higher pressures will produce faster O₂ diffusion rates resulting in higher O₂ reading and shorter cell life. To use a 3000 series analyzer at a cell pressure other than atmospheric, the analyzer must be calibrated with a known calibration gas at the new cell pressure to adjust for the different diffusion rate. Cell pressures below 2/3 atmospheric are not recommended because they tend to cause excessive internal expansion which may result in seal failure.

For operation at cell pressures other than atmospheric, care must be taken not to change the sample pressure rapidly or cell damage may occur. For cell pressures above atmospheric, caution must be exercised to avoid over pressuring the cell holder. (Percent analyzers will require some type of cell retainer to prevent the cell from being pushed out by the pressure). For operation at pressures below atmospheric pressure a suffix C (clamped) cell is required.

A.4.4 RESTRICTION DEVICES:

For proper operation, all 3000 series analyzers require a flow restriction device. This device is typically a restrictor or a valve. This restriction device serves two functions in the sample path. The first function is to limit the flow rate of the sample through the analyzer. A restrictor is chosen to operate over a range of pressures and provide a useable flow rate over that range.

The second function that the restriction device provides is a pressure drop. This device is selected to provide the only significant pressure drop in the sample path.

A.4.5 RESTRICTOR KIT

The current revision of the 3000 series analyzers are supplied with a kit containing two restrictors and a union which are user installed. These parts supplied to give the end user more flexibility when installing the analyzer. The restrictor kit is suitable for high and low positive pressure applications as well as vacuum service (atmospheric pressure sample) applications (see manual for installation instructions).

The standard restrictor (BLUE DOT) is recommended for pressures between 5 psig and 50 psig. For positive low pressure application (5 psig or less) the un-marked restrictor is better suited. For non-pressurized sample applications the marked restrictor should be used and configured for vacuum service.

For extremely low positive pressure applications (less than 2 psig) the vacuum service configuration should provide higher performance (higher flow rates). For vacuum service the end user must supply a vacuum pump and a bypass valve for the pump. A vacuum level of 5 - 10 inches of mercury should provide the optimum flow rate.

CAUTION: FLOW RESTRICTORS HAVE VERY SMALL ORIFICES AND MAY BE PLUGGED BY SMALL PARTICLES (.005" DIA OR LARGER) A SAMPLE FILTER MUST BE INCLUDED IN THE SAMPLE LINE PRIOR TO THE RESTRICTOR! A 60 MICRON FILTER IS RECOMMENDED.



A.4.6 3000RS EXAMPLES:

Example 1: With an incoming pressure of 10 psig the standard restrictor (blue dot) will provide a flow rate of .76 SLPM. Upstream of the restrictor the sample line pressure will be 10 psig, while downstream (including the cell) the pressure will be at atmospheric pressure (analyzer vented to atmospheric pressure). Note, all other pressure drops in the sample path are insignificant at these flowrates. This ensures that the cell operates at atmospheric pressure. At very high flow rates (off scale of flow-meter), pressure drops other than the restriction device could become significant, and result in pressurizing the cell.

Example 2: A 3000RS is configured for vacuum service as follows. The un-marked restrictor is placed in the sample vent port. The downstream end of the restrictor is then connected to a vacuum pump and bypass valve. The bypass valve is adjusted to provide a flow rate of 1 SLPM. The sample pressure between the pump and the restrictor will be approximately -7 inches of mercury, while the pressure in the balance of the sample system including the cell will be approximately at atmospheric pressure. (Provided the sample flow into the analyzer is not blocked.)

A.4.7 BYPASS:

To improve the system response, a bypass can be added to increase the sample flow rate to the analyzer by a factor of ten. A bypass provides a sample flow path around the analyzer of 2-18 scfh, typically.

A.4.8 CALIBRATION GAS:

For 3000 series analyzers with the Auto-Cal option, the customer must supply control valves (or restrictors) for any SPAN or ZERO gas source which is attached to the Auto-Cal ports. The valve should be adjusted to the same flow rate as the sample gas. When restrictors are used, the gas pressure must be adjusted to achieve the proper flow rate.

A.4.9 OPERATION WITHOUT A RESTRICTORDEVICE:

Operation without a restrictor device is not recommended as mentioned above. A 3000T (non-touch screen version) without any flow restrictor device was tested on 11-19-97. This results in a flow rate of 2.4 slpm at 1 psig. This is a cv of 0.023 for the standard sample system. Same results and recommendations should apply to 3000RS series.

REFERENCE: FLOW_1 .XLS & FLOW_2.XLS for information on flow rates at various pressures.

A.4.10 TAI PART NUMBERS

O165	O-ring Buna-N
A96117	1/8" tube restrictor kit
R3778	Blue Dot Std. Restrictor
R3779	(low pressure /vac. service) restrictor
U211	1/8" Union (SS)
A91605	Flow Sensor and Cable Assy
C94750A	Back Panel PC Board
C94756A	Front Panel Touchscreen Interface Board (no touchscreen included)
C94747B	Main PC Board (Trace option)
C94759A	Front Panel Interface PCB (no touchscreen included)
C94753B	Mid Plane PCB (3000RS-T option)
CP60	LCD 3.5" Touchscreen

A.4.11 CONVERSIONS:

1 PSI	=	2.04 INCHES OF MERCURY (in. Hg.)
1 SCFH	=	0.476 SLPM

A.5 Material Safety Data Sheet

Section I - Product Identification

Product Name: Micro-fuel Cells
Mini-Micro-fuel Cells
Super Cell, all classes except T-5F
Electrochemical Oxygen Sensors, all classes

Manufacturer: Teledyne Electronic Technologies
Analytical Instruments

Address: 16380 Chestnut Street,
City of Industry, CA 91749

Phone: (626) 961-9221

Technical Support: (626) 934-1673

**Environment, Health
and Safety:** (626) 934-1592

Date Prepared: 11/23/98

Section II - Physical and Chemical Data

**Chemical and
Common Names:** Potassium Hydroxide (KOH), 15% (w/v)
Lead (Pb), pure

CAS Number: KOH 1310-58-3
Pb 7439-92-1

	KOH (15% w/v)	Pb (pure)
Melting Point/Range:	-10 to 0 °C	328 °C
Boiling Point/Range:	100 to 115 °C	1744 °C
Specific Gravity:	1.09 @ 20 °C	11.34
pH:	>14	N/A
Solubility in Water:	Completely soluble	Insoluble
Percent Volatiles by Vol.:	None	N/A
Appearance and Odor:	Colorless, odorless solution	Grey metal, odorless

Section III -Physical Hazards

Potential for fire and explosion: The electrolyte in the Micro-fuel Cells is not flammable. There are no fire or explosion hazards associated with Micro-fuel Cells.

Potential for reactivity: The sensors are stable under normal conditions of use. Avoid contact between the sensor electrolyte and strong acids.

Section IV - Health Hazard Data

Primary route of entry: Ingestion, eye/skin contact

Exposure limits: 0.05 mg./cu.m. (Pb)
 OSHA PEL: 2 mg/ cu.m. (KOH)
 ACGIH TLV:

Effects of overexposure

- Ingestion:** The electrolyte could be harmful or fatal if swallowed.
Oral LD50 (RAT) = 3650 mg/kg
- Eye:** The electrolyte is corrosive; eye contact could result in permanent loss of vision.
- Dermal:** The electrolyte is corrosive; skin contact could result in a chemical burn.
- Inhalation:** Liquid inhalation is unlikely.

Signs/symptoms of exposure: Contact with skin or eyes will cause a burning sensation and/or feel soapy or slippery to touch.

Medical conditions aggravated by exposure: None

Carcinogenicity: NTP Annual Report on Carcinogens: Not listed
LARC Monographs: Not listed
OSHA: Not listed

Other health hazards: Lead is listed as a chemical known to the State of California to cause birth defects or other reproductive harm.

Section V - Emergency and First Aid Procedures

Eye Contact: Flush eyes with water for at least 15 minutes and get immediate medical attention.

Skin Contact: Wash affected area with plenty of water and remove contaminated clothing. If burning persists, seek medical attention.

Ingestion: Give plenty of cold water. Do not induce vomiting. Seek medical attention. Do not administer liquids to an unconscious person.

Inhalation: Liquid inhalation is unlikely.

Section VI - Handling Information

NOTE: The oxygen sensors are sealed, and under normal circumstances, the contents of the sensors do not present a health hazard. The following information is given as a guide in the event that a cell leaks.

Protective clothing: Rubber gloves, chemical splash goggles.

Clean-up procedures: Wipe down the area several times with a wet paper towel. Use a fresh towel each time.

Protective measures during cell replacement: Before opening the bag containing the sensor cell, check the sensor cell for leakage. If the sensor cell leaks, do not open the bag. If there is liquid around the cell while in the instrument, put on gloves and eye protection before removing the cell.

Disposal: Should be in accordance with all applicable state, local and federal regulations.

NOTE: The above information is derived from the MSDS provided by the manufacturer. The information is believed to be correct but does not purport to be all inclusive and shall be used only as a guide. Teledyne Analytical Instruments shall not be held liable for any damage resulting from handling or from contact with the above product.

1

2

3

4

NOTES: UNLESS OTHERWISE SPECIFIED.

DEMENTIONS, MM [], INCHES

REV.	DESCRIPTION	DATE	APP.	REV BY
0	INITIAL RELEASE	3/8/24	KFP	KFP

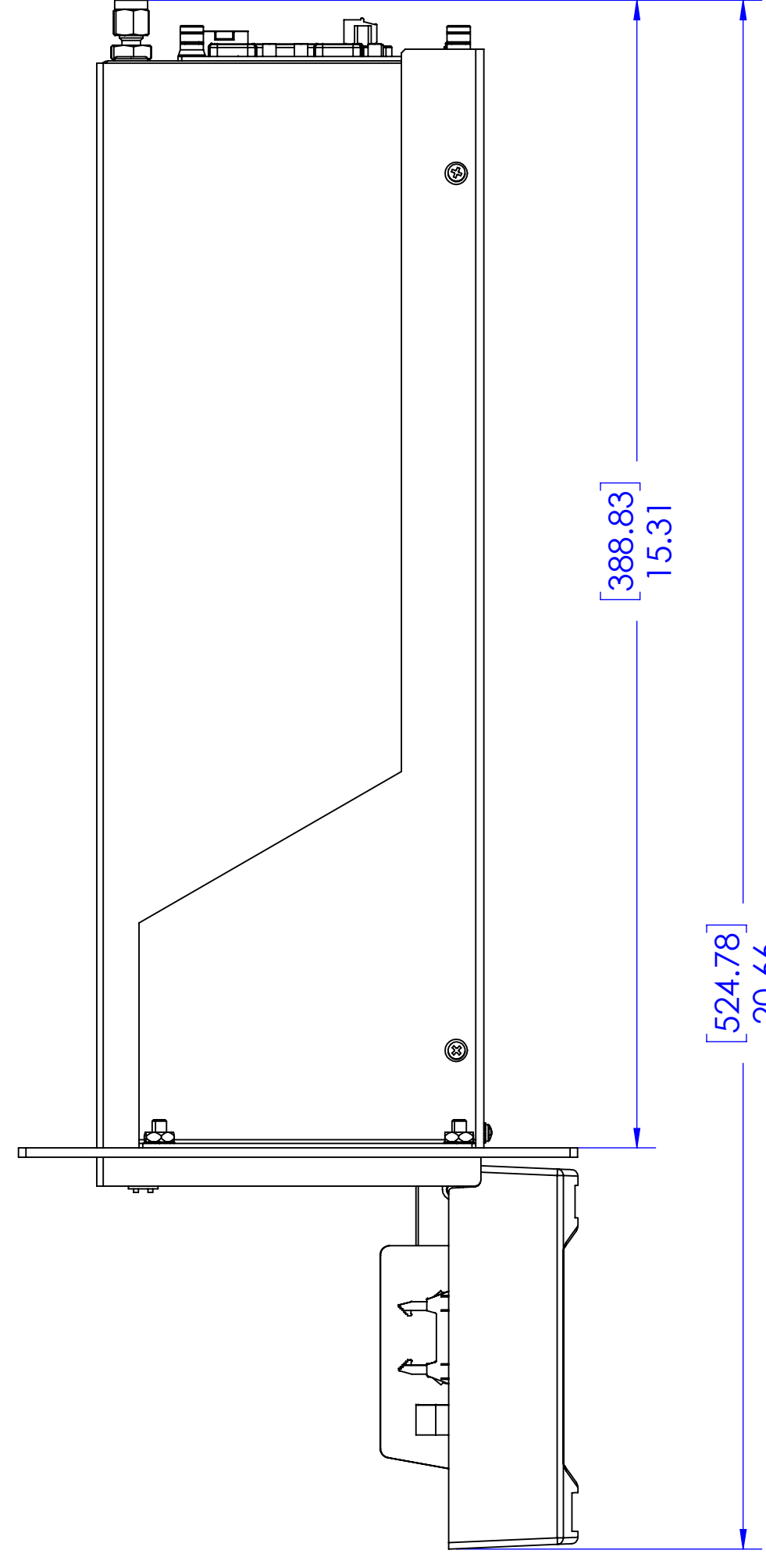
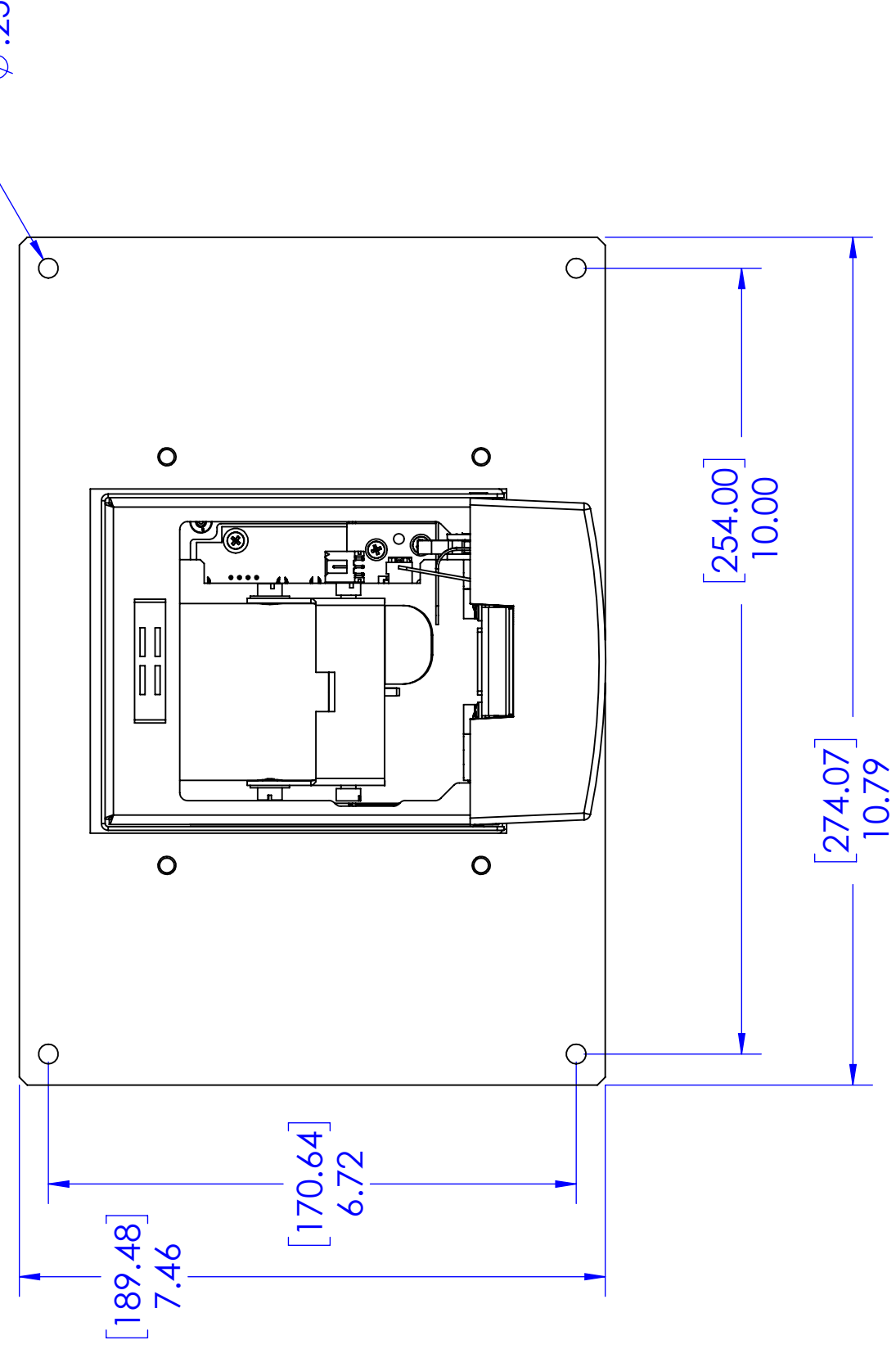
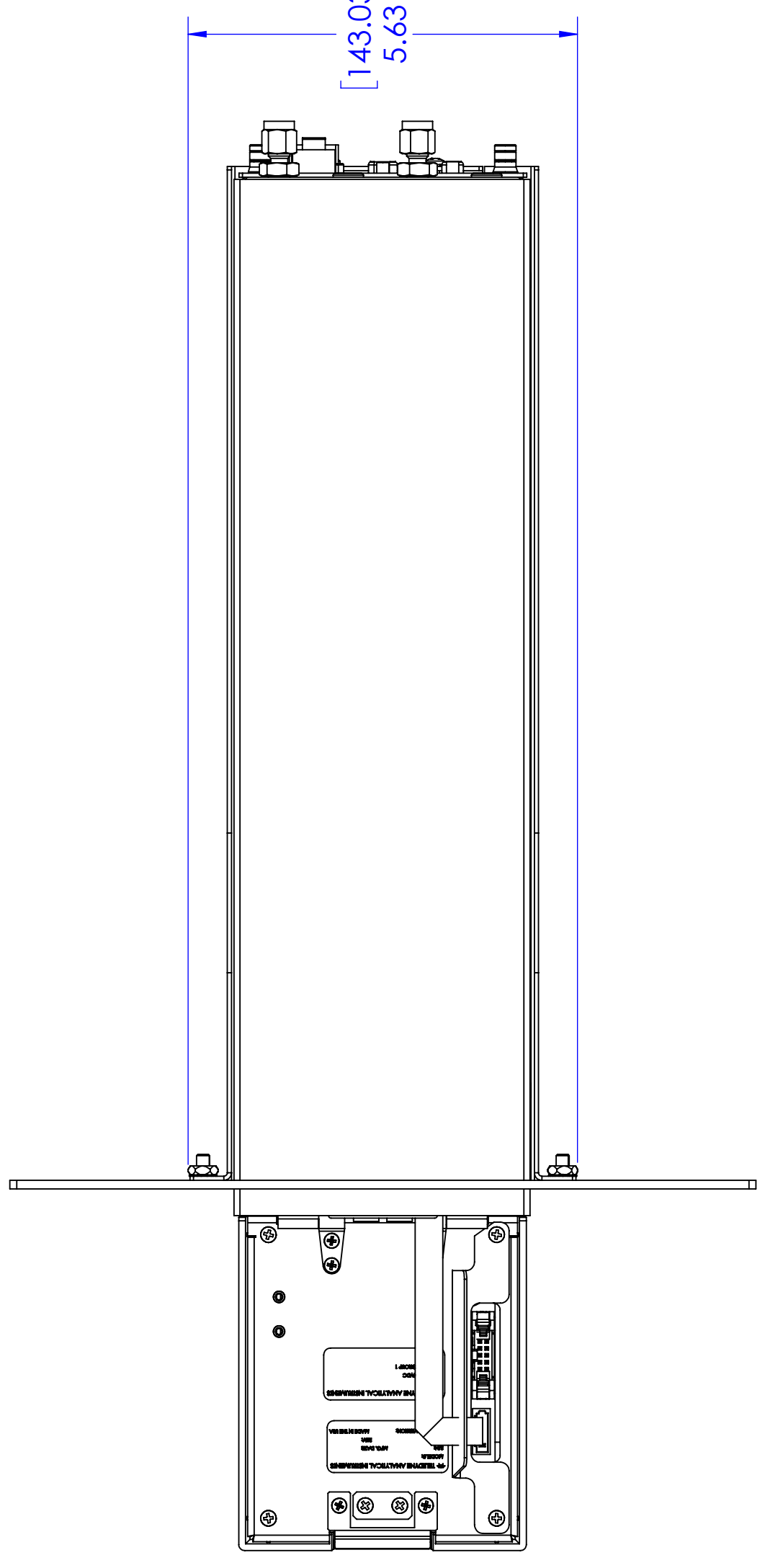

A

A

DO NOT SCALE DRAWING		BILL OF MATERIALS	
TOLERANCE UNLESS OTHERWISE SPECIFIED: ANGULAR ±1/2°		THIS DRAWING IS THE PROPERTY OF TELEDYNE ANALYTICAL INSTRUMENTS AND CONTAINS CONFIDENTIAL INFORMATION. IT IS NOT TO BE COPIED, REPRODUCED, OR USED WITHOUT WRITTEN PERMISSION.	
LINEAR { X = ±0.1 XX = ±0.02 XXX = ±0.010		Teledyne Analytical Instruments A Teledyne Technologies Company CITY OF INDUSTRY, CALIFORNIA 91748, USA	
SIGNATURES	DATE	TITLE	SCALE
DRFT: KFP	3/8/24	RS SERIES PANEL MOUNT ADAPTER OUTLINE WITH ANALYZER	1:5
CHK:			SIM C96118
APPR:			SHEET 1 OF 2
ENGR: KFP			REV 0
S.O.			DWG NO. C96143
REFERENCE	CAD ID C96143-0	MATL:	NOTED

A SERIES PROFILE DETAIL

1

2

3

4

1

2

3

4

REVISIONS
SEE SHEET 1

D

D

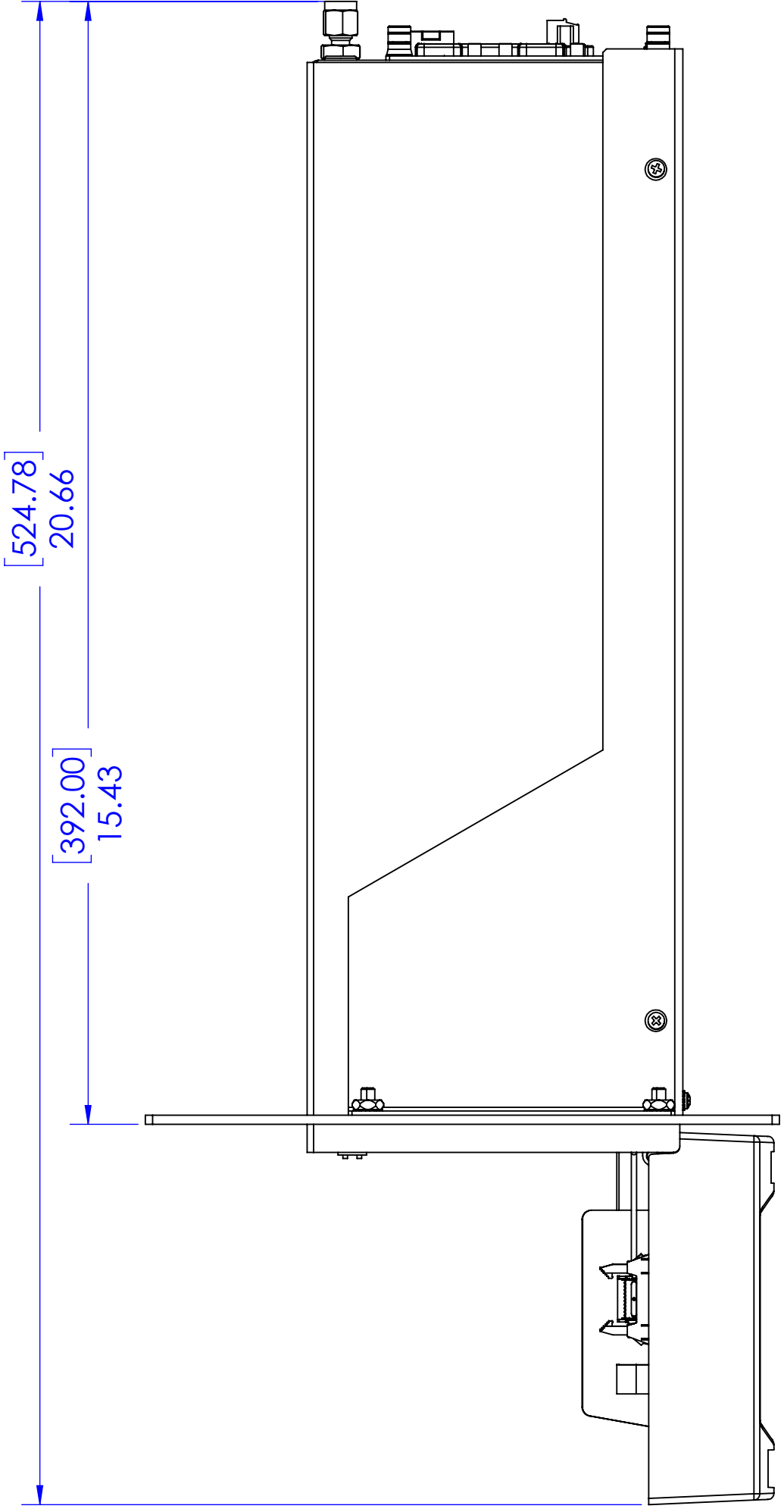
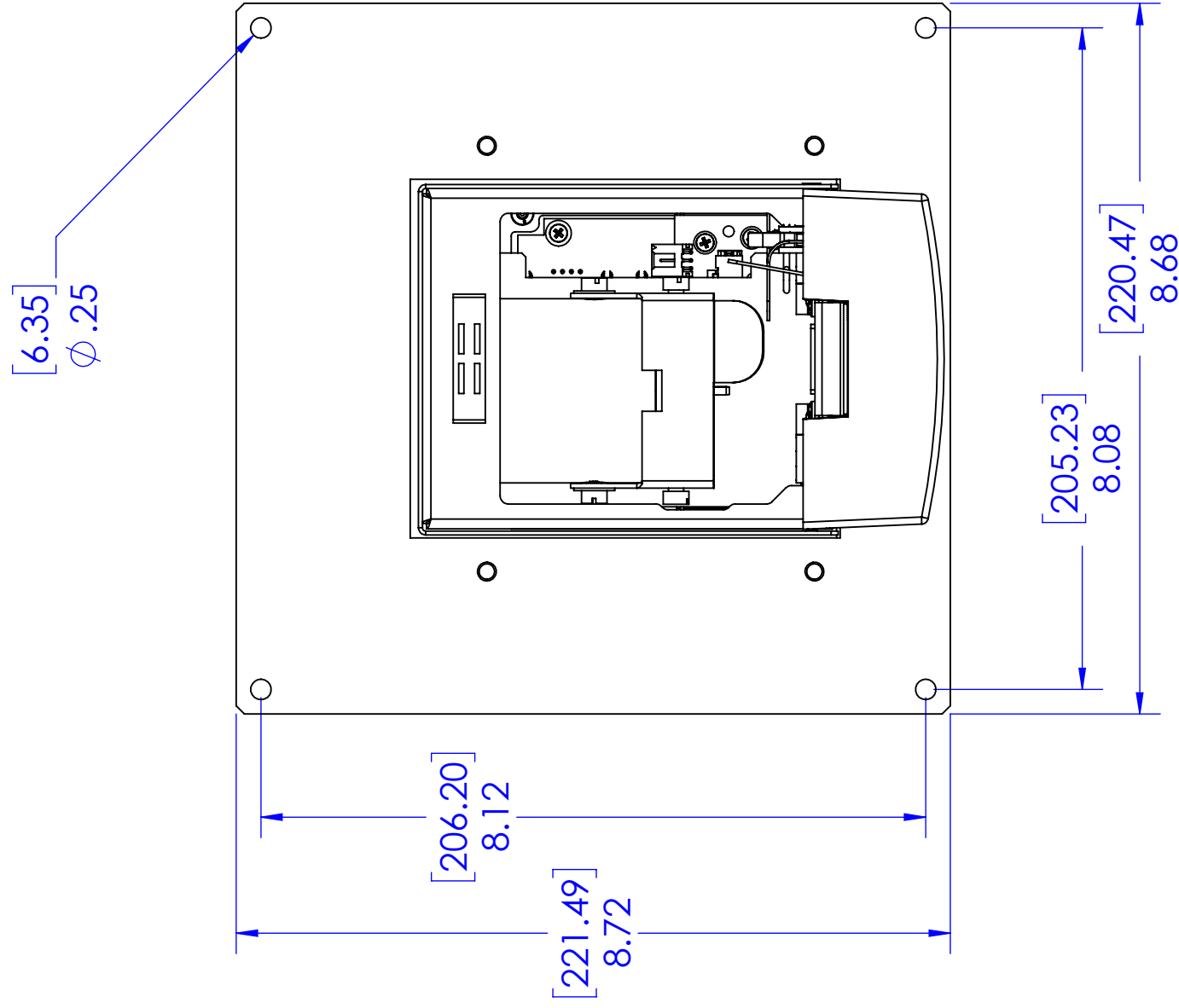

C

C

B

B

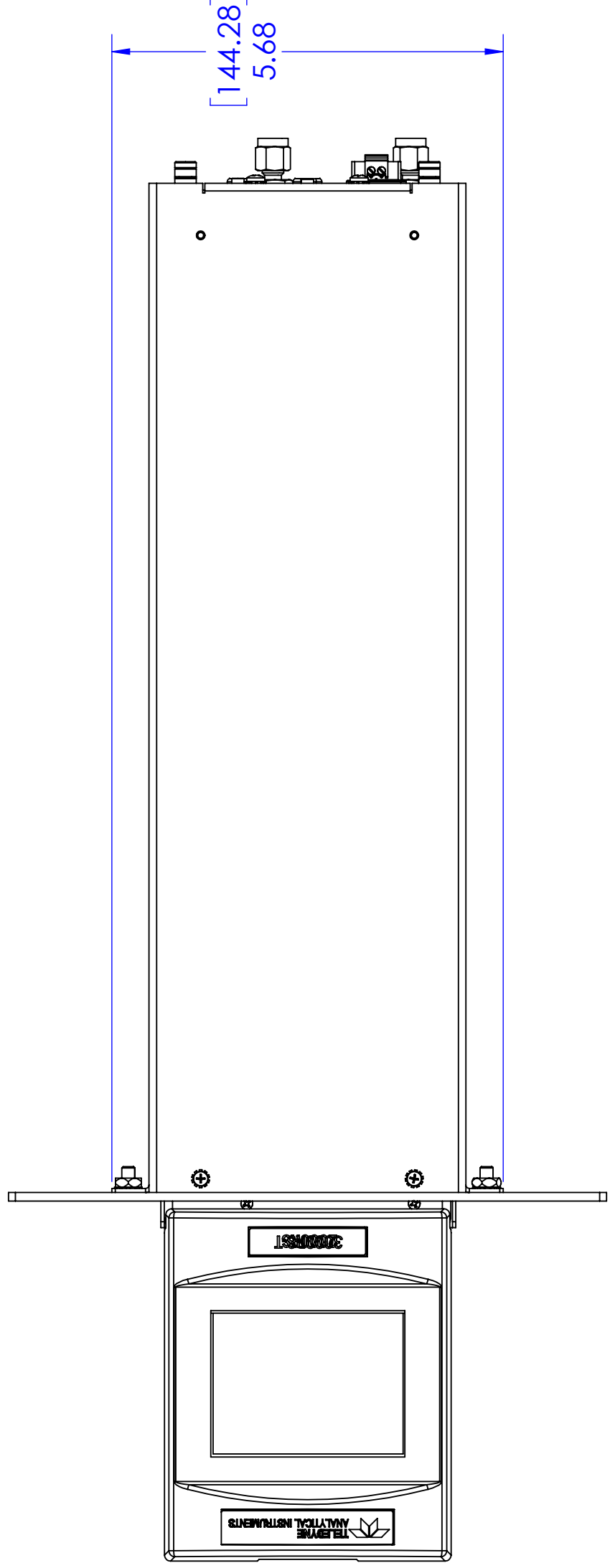

A

A

VB PROFILE ADAPTER DETAIL

SHEET
2 OF 2

DWG. NO.
C-96143

REV
0

4

3

2

1

4

NOTES: UNLESS OTHERWISE SPECIFIED.

DEMENTIONS, MM [], INCHES

3

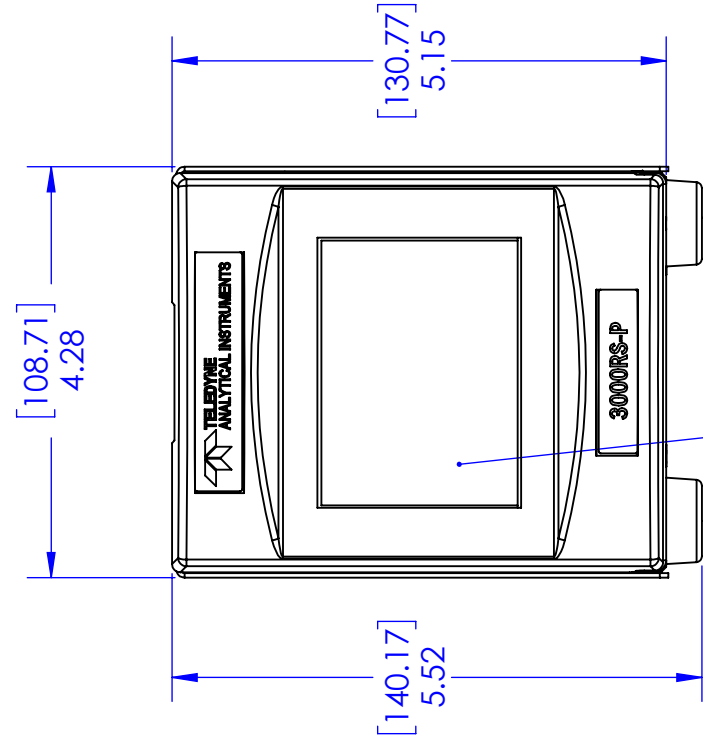

2

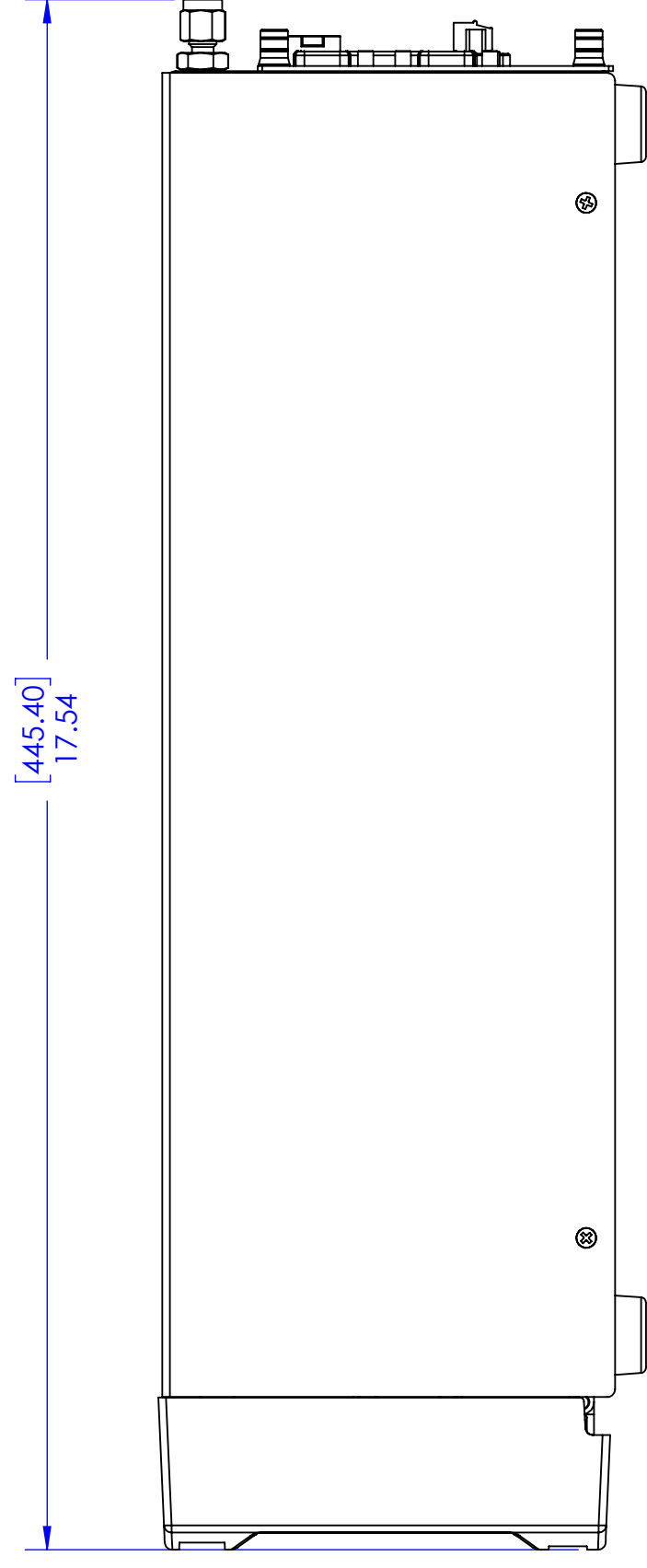

1

REV	DESCRIPTION	DATE	APP.	REV BY
0	INITIAL RELEASE	10/12/23	KFP	

D

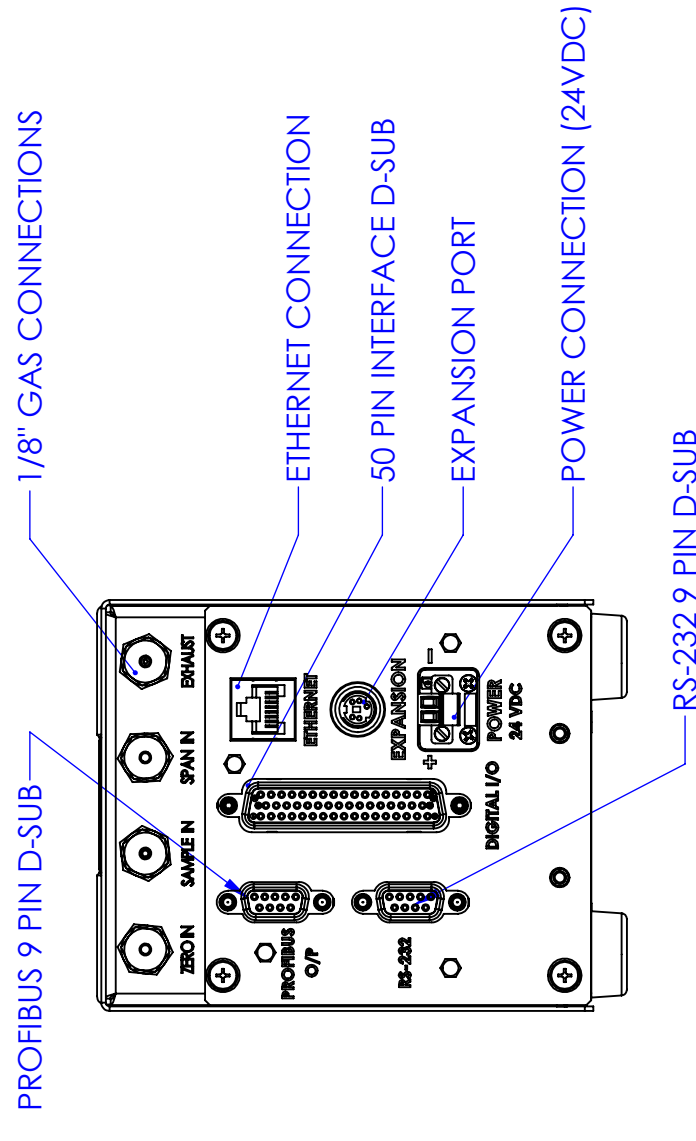

C

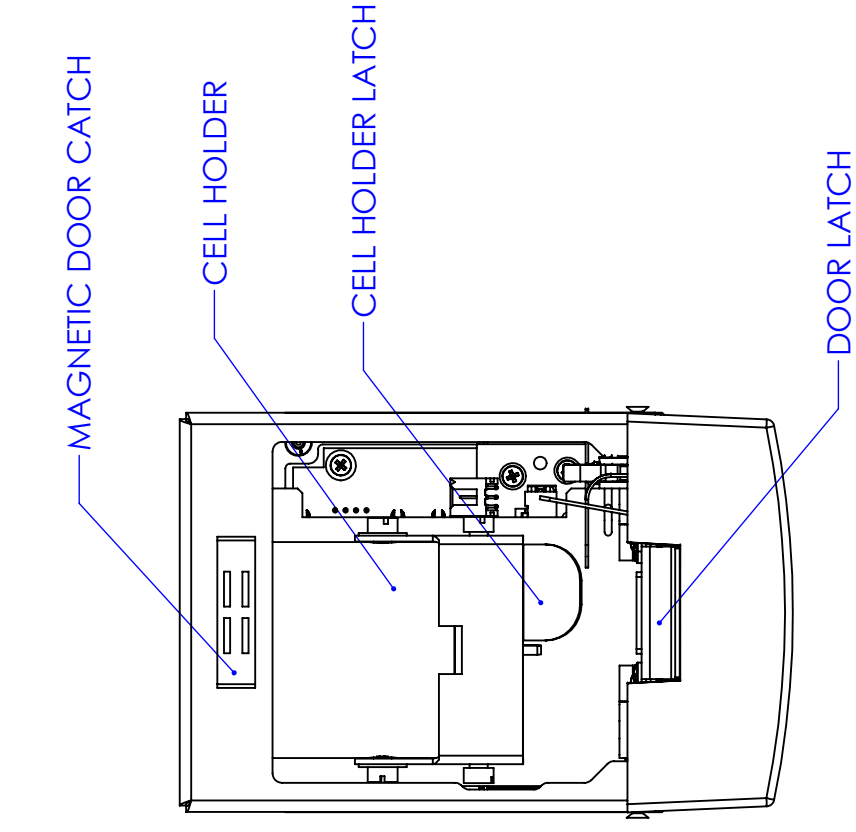

B

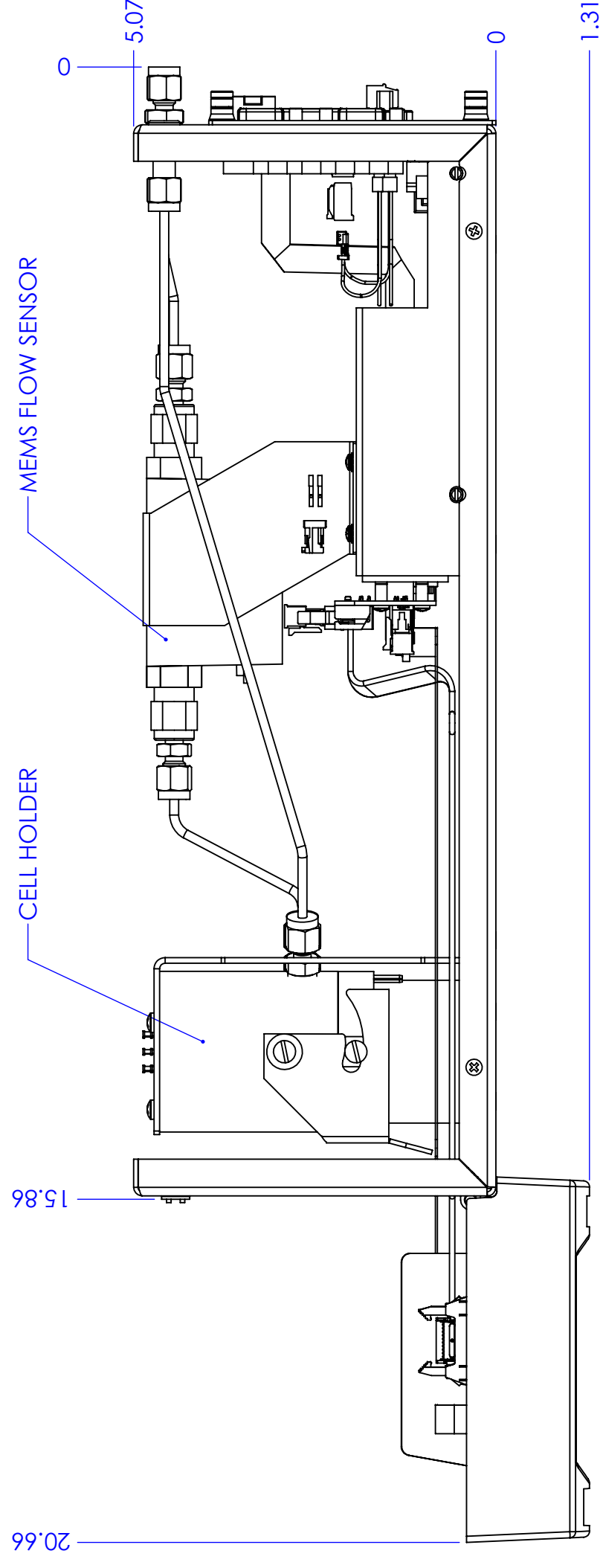

A

DO NOT SCALE DRAWING		BILL OF MATERIALS	
THIS DRAWING IS THE PROPERTY OF TELEDYNE ANALYTICAL INSTRUMENTS AND CONTAINS CONFIDENTIAL INFORMATION. IT IS NOT TO BE COPIED, REPRODUCED OR USED WITHOUT WRITTEN PERMISSION.			
TOLERANCE UNLESS OTHERWISE SPECIFIED: ANGULAR ±1/2°		Teledyne Analytical Instruments A Teledyne Technologies Company CITY OF INDUSTRY, CALIFORNIA 91748, USA	
LINEAR { X = ±0.1 XX = ±0.02 XXX = ±0.010	DATE	TITLE	
	10/12/23	RS SERIES SINGLE MODULE OUTLINE	
SIGNATURES		SCALE	1:5
DRAFT: KFP		SIM	
CHK:		SHEET	1 OF 1
APPR:		REV	0
ENGR: KFP		DWG NO.	C96118
S.O.		MATL:	NOTED
REFERENCE	CAD ID C96118-0		

4

3

2

1